



PROMOTIONS

DU 01^{ER} JANVIER AU 31 MARS

2026

Offres de début d'année
2026

L'EXCELLENCE AU SERVICE DES CABINETS DENTAIRES



Matériel premium, design moderne, décliné en plusieurs couleurs pour s'adapter à votre environnement. Avec ProdentAlpes, offrez à votre cabinet des équipements alliant performance, confort et esthétique.

NOS ATOUTS

- ✓ **Qualité et fiabilité** – Des produits sélectionnés pour leur durabilité et leur efficacité
- ✓ **Confort et ergonomie** – Pensés pour améliorer l'expérience des praticiens et des patients.
- ✓ **Service expert et réactif** – Un accompagnement personnalisé pour répondre à vos besoins.

CONTACTEZ-NOUS

✉ contact@prodentalpes.fr

☎ 06 01 21 16 35



prodentalpes.fr

ZI DES DRAGIEZ, 30 RUE DE GRÉBELIN,
74800 LA ROCHE-SUR-FORON

Die Firma HLW Dental-Instruments Germany besteht seit 1993.

Wir produzieren und vertreiben Dentalinstrumente weltweit.

Unsere Schwerpunkte:

Chirurgie
Parodontologie
Implantologie
Orthodontie



Dental-Instruments Germany
every time a good decision.

The company HLW Dental-Instruments Germany was founded in 1993.

We are manufacturing and distributing high grade instruments for dentistry

Our priorities:

Surgical
Parodontology
Implantology
Orthodontic



Firmengebäude



Ausstellung

Garantie Garantie

ZERTIFIKAT

DIN EN ISO 13485

PÜG Prüf- und Überwachungsgesellschaft mbH
bescheinigt hiermit, dass das Unternehmen



Zertifikatsinhaber: HLW Dentalinstruments GmbH
Daimlerstraße 19, 92533 Wernberg-Köblitz

Bereiche: Herstellung und Vertrieb von Dentalinstrumenten

ein Qualitätsmanagementsystem entsprechend der DIN EN ISO 13485:2016 eingeführt hat und dieses wirksam anwendet.

Der Nachweis wurde im Rahmen des Zertifizierungs-Audits erbracht.

Dieses Zertifikat ist gültig vom: 01.12.2021
bis: 30.11.2024

Auditbericht-Nr. 22112021_K24522

Zertifikat-Registrier-Nr. K24522-20211201-D-de



Gäufelden, 01.12.2021

Leitung der Zertifizierungsstelle
Gesundheitswesen

PÜG Prüf- und Überwachungsgesellschaft mbH | Hämmerlestraße 14 + 16 | 71126 Gäufelden
Telefon (0 70 32) 28 91-0 | Fax (0 70 32) 28 91-111 | info@pueg.de | www.pueg.de

CERTIFICATE

DIN EN ISO 13485

PÜG Prüf- und Überwachungsgesellschaft mbH
herewith certifies that the company



Certificate holder: HLW Dentalinstruments GmbH
Daimlerstraße 19, 92533 Wernberg-Köblitz
Germany

Scope: Production and distribution of dental instruments

introduced a quality system in accordance with DIN EN ISO 13485:2016 and uses this effectively.

The evidence has been provided within the framework of the certification audit.

This certificate is valid from: 2021-12-01
until: 2024-11-30

Audit report no: 22112021_K24522

Certificate registration no. K24522-20211201-D-en



Gäufelden, 2021-12-01

Magical of Certification Authority
Health care

This is the translation of the original German certificate. For legal reasons, the original German certificate is valid.

PÜG Prüf- und Überwachungsgesellschaft mbH | Hämmerlestraße 14 + 16 | 71126 Gäufelden
Telefon (0 70 32) 28 91-0 | Fax (0 70 32) 28 91-111 | info@pueg.de | www.pueg.de

Hinweis

Wir sind ständig bestrebt Qualität und Ausführung unserer Produkte zu verbessern. In diesem Zusammenhang behalten wir uns ausdrücklich das Recht vor, Lieferprogramm und Instrumente ohne vorherige Ankündigung zu ändern und die Garantie-, Liefer- und Zahlungsbedingungen fortzuentwickeln und veränderten rechtlichen Gegebenheiten anzupassen.

Mit Erscheinen dieses Kataloges verlieren alle früheren Ausgaben ihre Gültigkeit.

Copyright

Dieser Katalog bleibt ausschließliches Eigentum von HLW Dental Instruments. Die Nutzung und Weitergabe des Kataloges ist nur Händlern gestattet, die ausschließlich HLW-Instrumente ein- und verkaufen. Jeder Nachdruck oder anderweitige Vervielfältigung dieses Kataloges bzw. von Teilen davon oder auch auszugsweise, sowie die Übertragung bzw. Nutzung des Kataloges in Speichermedien jeder Art ist auch auszugsweise verboten.

Note

We are permanently solicitous to improve quality, design and configuration of our products. Therefore we reserve the right to alterate product-range and design of instruments without prior notice. So far our terms of guarantee, delivery and payment are subject to further development and adjustment to changing legal frame conditions, too.

This issue of catalogue invalidate all prior editions.

Copyright

This catalogue remains an exclusive property of HLW Dental Instruments. Use and distribution of the catalogue is limited to our customers dealing exclusively with our instruments. Each reprint of otherwise reproduction of this catalogue or of parts of it, such as the transfer or use of catalogue or its components in storage media of and kind even partially is prohibited.



A

Abdrucklöffel	200–207
Alginatspatel	188
Amalgaminstrumente	172–173
Amalgampistole	63
Applikatoren	7–8
Arterienklemmen	97–98
Artikulationspinzette	118
Aspirationsspritzen	76–77

B

Bondingpinsel	8
Brenngutpinzette	185

C

Codierringe	147, 203
-------------	----------

D

Distalschneider	189
Drahtbiegezangen	191–197
Drahtschneider	189

E

Excavatoren	160–163
-------------	---------

F

Fadenleger	173
Flachzangen	191
Fotospiegel	125
Füllungsinstrumente	165–171

G

Gewebezange	58
Gingivalanschräger	174
Gipsmesser	187
Gipsspatel	188
Gipszange	185

H

Hammer	64
Heidemannspatel	165
Hohlmeißelzangen	57

I

Injektionsspritzen	76–77
Instrumentenschalen	70–71
Interdentalbürsten	5–6
Intraoralspiegel	125

K

Kinderzangen	28–32
Klammerboard	81
Knochenfeile	150
Knochenzangen	57
Kofferdam	81
Kofferdam-Klammern	80
Kofferdamrahmen	81
Kofferdamzangen	79
Kronenaufbieger	178
Kronenentferner	74
Kronenmesser	184
Kronenzangen	23

L

Laborinstrumente	181–198
Lötpinzetten	185
Luxierer	48–51

M

Matrizenbänder	111–112
Matrizenspanner	111–112
Micro Tips	8
Microtools	54–55
Mikronadelhalter	103, 104, 108, 109
Mikropinzetten	119–120
Mikroschere	92, 94
Mikrospiegel	124
Mundspiegel	123–124
Mundspiegelgriffe	126
Mundspreitser	60
Mustermappen	9–10

N

Nadelhalter	100–109
Nagelschere	83

O

Ochsenbein P.A. Meißel	150
Ofenzangen	183

P

P.A. Küretten	140–146, 148, 151
P.A. Scaler	136–139, 149, 151
P.A. Sonden	157
P.K. Thomas	182
Periotome	150
Pinselfaltegrieffe	5, 8
Pinzetten	114–120
Planator	174
Prophylaxe	4–6

R

Raspatoren	176–177
------------	---------

S

Scaler	136–139, 149
Separator	72
Skalpellgriff	179
Sonden	153–157
Spiegelgriffe	126
Spirituslampe	70
Spritzenhaltezeuge	64
Scharfe Löffel	32–34
Scheren	83–95
Schlaufensystem	72
Scherenzange	13

T

Tamponstopfer	173
Tasterzirkel	184
Teleskopkronenzange	198
Titannitridinstrumente	129–130
Trays	70–71
Tuchklemmen	99

U

Ultraschallgerät	73
------------------	----

W

Wachsmesser	186
Wachsmo- dellier- instrumente	181–182
Wangenhalter	61–63
Waschkörbe	69
Wasch-Trays Implant.	67–68
Wasch-Trays Instr.	65–66
Wasserspritze	13
Wattspender	70
Wundhaken	61–63, 72
Wundspreitser	72
Wurzelheber	34–47
Wurzelkanalweiterer	158
Wurzelkanalstopfer	158
Wurzelspitzenzangen	52
Wurzelsplitterheber	53

Z

Zahnsonden	153–157
Zahnzangen	14–32
Zementspatel	181
Zungenbügel	184

A	
Alginat spatula	188
Amalgam gun	63
Amalgam instruments	172–173
Applicators	7–8
Aspirating syringe	76–77
B	
Bonding brushes	8
Bone curettes	32–34
Bone rongeurs	57
Brush holder	5, 8
Bonefile	150
C	
Calibers	184
Children forceps	28–32
Clamp board	81
Colour coding	147, 203
Crown bender	178
Crown loop system	72
Crown pliers	23
Crown remover	74
D	
Distal cutter	189
E	
Extracting forceps	14–32
Excavators	106–163
F	
Filling instruments	165–171
G	
Gingivalinstr.	174

H	
Hammer	64
Handles for brushes	5, 8
Heating forceps	183
Heidemann spatula	165
Hemostatic forceps	97–98

I	
Impression trays	200–207
Interdental brushes	5–6
Intra oral mirrors	125

L	
Laboratory instruments	181–198
Luxierer	48–51

M	
Matrix	111–112
Matrix retainers	111–112
Mesh Basket	69
Micro	
needle holder	103, 104, 108, 109
Micro scissors	92, 94
Micro mirror	124
Micro-Tools	54–55
Micro tweezer	119, 120
Mirror handle	126
Mirrors	123–124

N	
Needle holder	100–109
Nail scissors	83

O	
Ochsenbein chisel	150

P	
P.A. curettes	140–146, 148, 151
P.A. probes	157
P.A. scaler	136–139, 149, 151
P.K. Thomas	182
Paper articulator	118
Periotome	150
Planator	174
Plaster knife	187
Plaster spatula	188
Pliers	191–197
Prophylaxe	4–6

R	
Raspatories	176–177
Retainers	111–112
Retractors	61–63, 72
Root elevators	34–47
Root plugger	158
Rubber dam	81
Rubber dam arch	81
Rubber dam clamp	80
Rubber dam forceps	79

S	
Sample cases	9–10
Scalers	136–139, 149
Scalpel handle	179
Scissors	83–95
Scissor forceps	13
Separator	72
Soldering tweezer	185
Spreader	158
Spiritus lamp	70
Syringe	76–77
Syringe holding forceps	64

T	
Telescope crown forceps	198
Tissue forceps	58
Titanium instruments	129–130
Towel forceps	99
Trays	70–71
Tweezers	114–120

U	
Ultrasonic machine	73

W	
Wash-Trays Implant.	67–68
Wash-Trays Instr.	65–66
Water Syringe	13
Wire bending pliers	191–197
Wire cutter (TC)	189

Prophylaxe



Applikatoren Applicators

Interdental Bürstenhalter Interdental holder

Interdental Bürsten Interdental brushes

Musteretuis Show Cases

Interdental Bürstenhalter doppelendig Interdental holder double-ended



Ref. 10-1
weiss



Ref. 10-2
rot



Ref. 10-3
orange

Interdental Bürsteneinsätze Interdental brushes

fein / fine

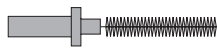

Ref. 10-101
12 Stück/pcs



Ref. 10-102
12 Stück/pcs

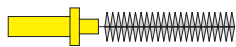

Ref. 10-103
12 Stück/pcs

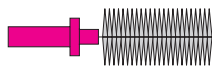

Ref. 10-104
12 Stück/pcs

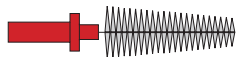

Ref. 10-105
12 Stück/pcs

mittel / medium

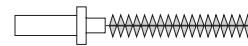

Ref. 10-106
12 Stück/pcs

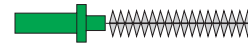

Ref. 10-107
12 Stück/pcs

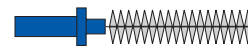

Ref. 10-108
12 Stück/pcs

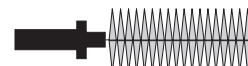

Ref. 10-109
12 Stück/pcs

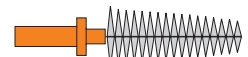

Ref. 10-110
12 Stück/pcs

Nylonbürsten für Prophylaxe Nylonbrushes

8.000-10.000 u./min.

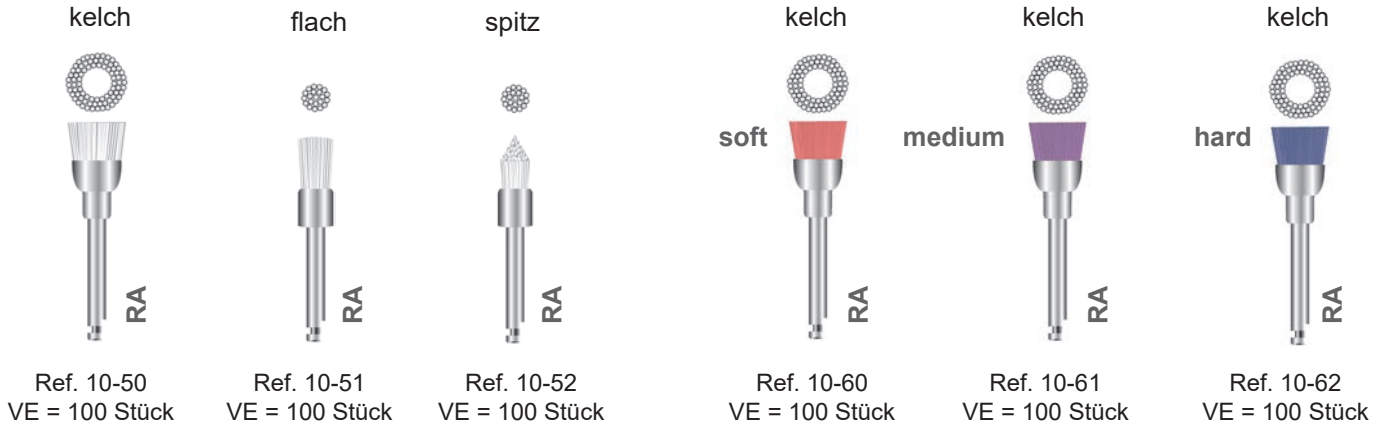

Prophylaxe Polierer

Zur schonenden Beseitigung von Zahnbelägen

8.000-10.000 u./min.

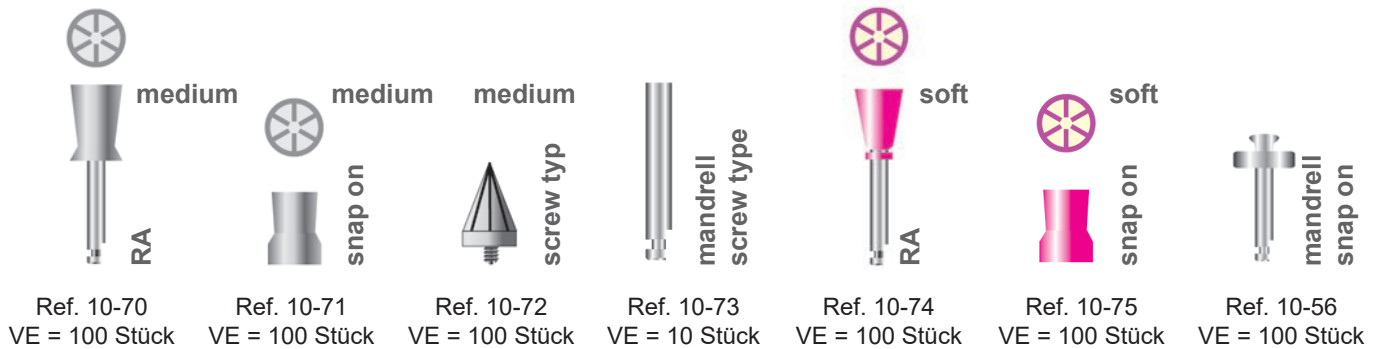

Interdental Bürsten mit Verschlusskappe

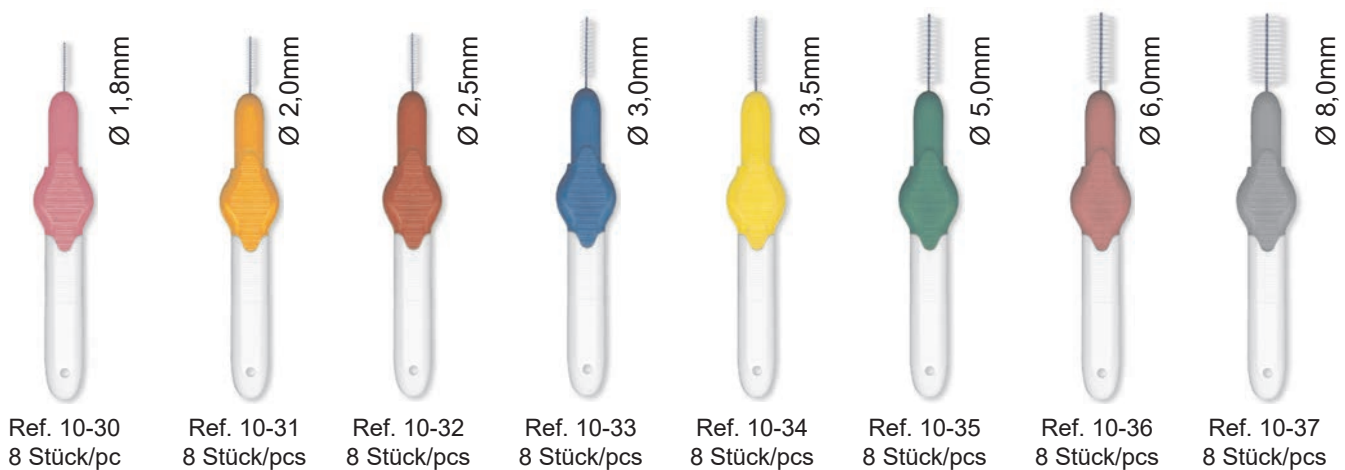

Applikatoren Applicators

Ref. 10-18 medium

Ref. 10-19 fine



Box 100 Stck./pcs

Box 100 Stck./pcs

Micro Tips Set

Inhalt: blau 100 Stück/pcs
gelb 100 Stück/pcs
grün 100 Stück/pcs
rot 100 Stück/pcs
2 x Pinselhalter
Ref. 10-20

Nachfüllpackung

ROT 100 Stück/pcs
Ref. 10-21

GELB 100 Stück/pcs
Ref. 10-22

GRÜN 100 Stück/pcs
Ref. 10-23

BLAU 100 Stück/pcs
Ref. 10-24

Pinselhalter

ROT 1 Stück/pcs
Ref. 10-2

WEISS 1 Stück/pcs
Ref. 10-1



Bondingpinsel

Ref. 10-11
Menge/Quantity 100 Stück



Pinselhalter für Bondingpinsel

Ref. 1009
Menge/Quantity 1 Stück

Ref. 1008
Menge/Quantity 10 Stück



Musteretuis Show Cases

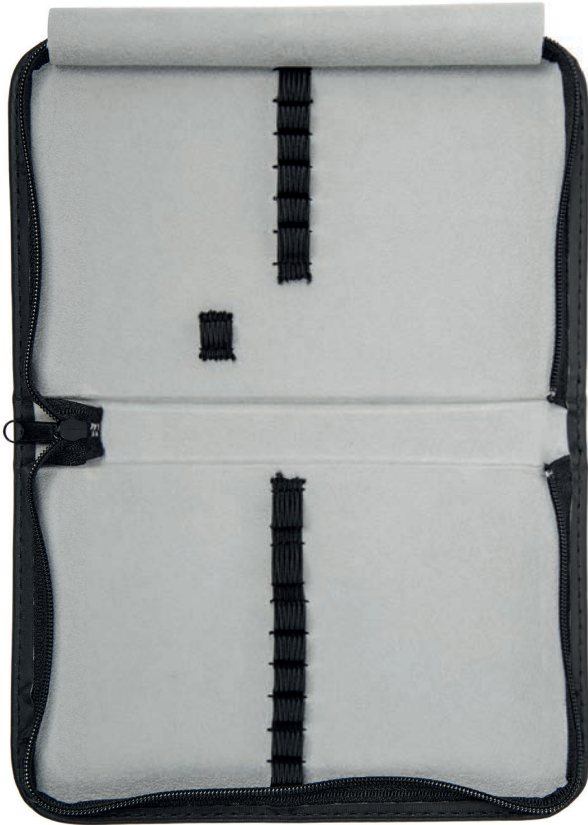

Maße: 24,0 x 19,0 cm
Ref. 10-12



Maße: 16,0 x 19,0 cm
Ref. 10-13

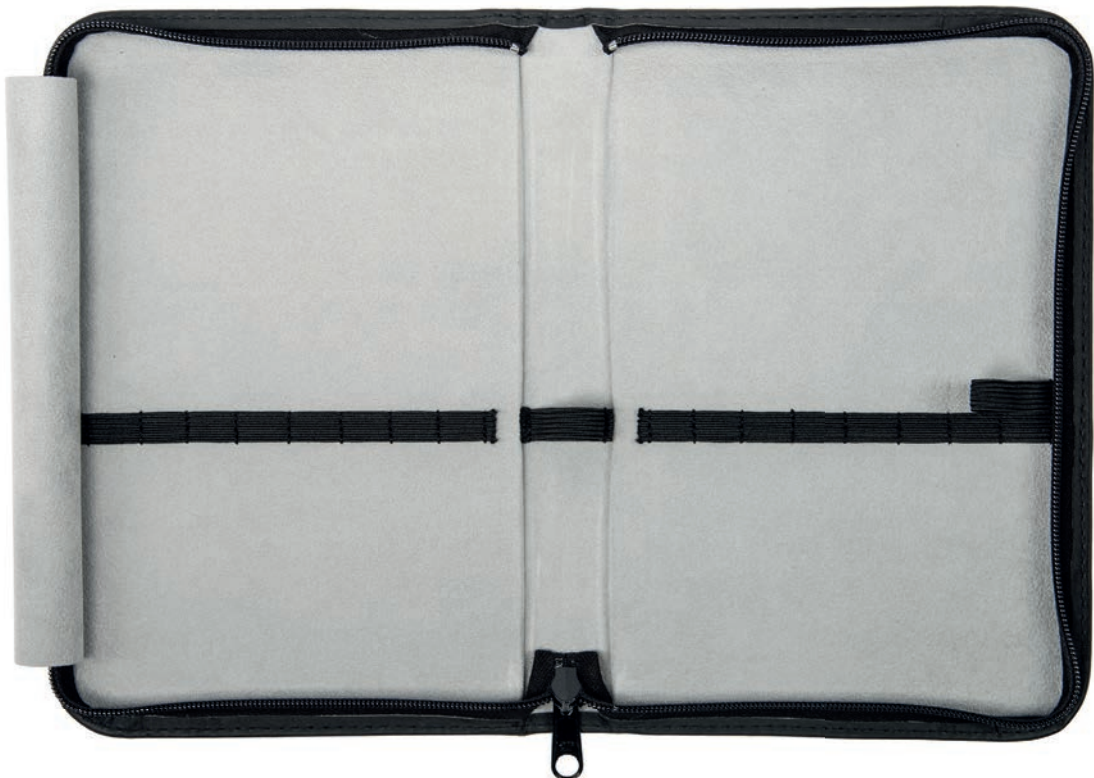

Maße: 33,0 x 23,0 cm
Ref. 10-14

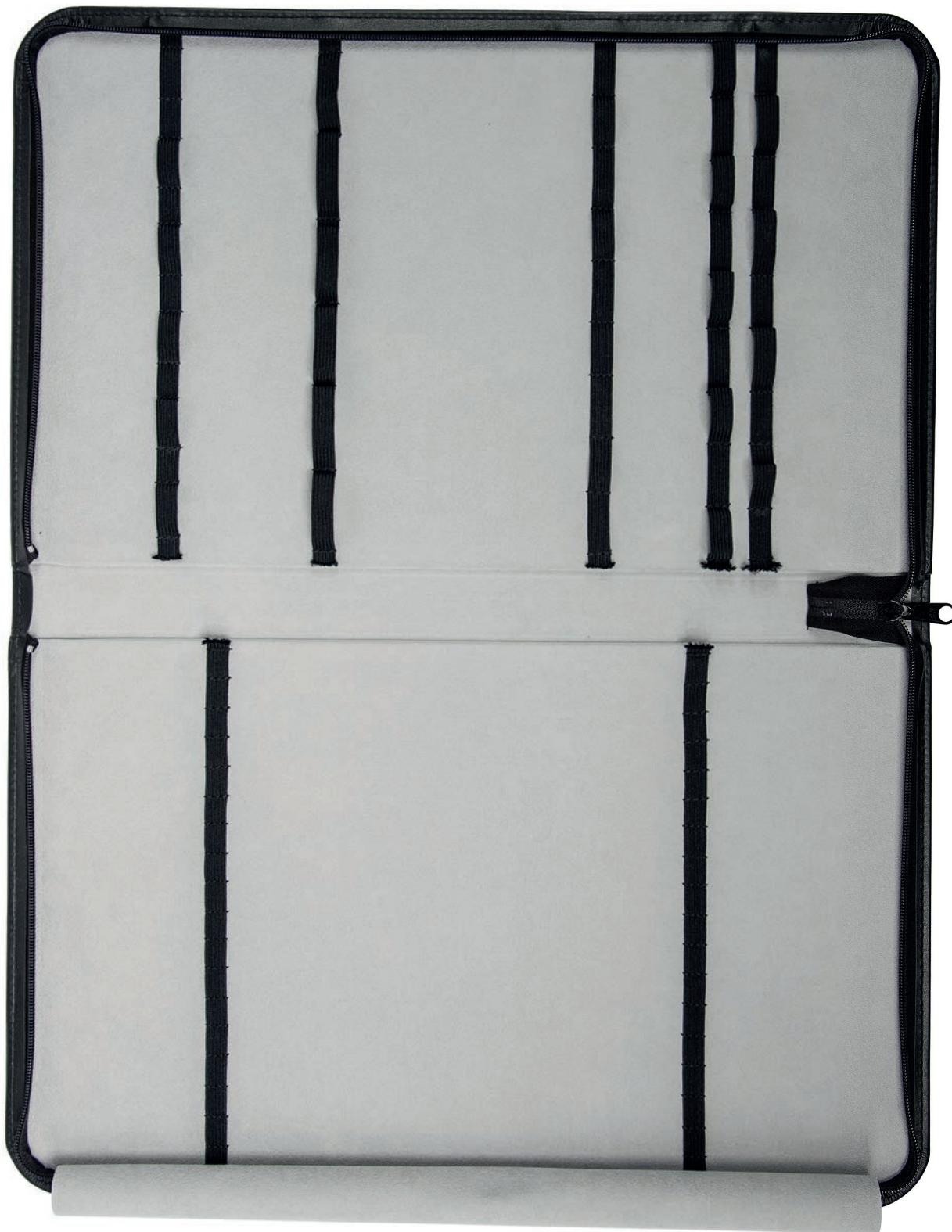

Maße: 44,0 x 57,0 cm
Ref. 10-15

Zangen Forceps



Zahnzangen Extracting Forceps

Kronenzangen Crown Forceps

Weisheitszahnzangen Wisdoms Forceps

Tiefgreifende Wurzelzangen Deep gripping root forceps

Kinderzahnzangen Extracting Forceps for children

Alle Zahnzangen sind mit einem Haftprofil ausgestattet (Kreuzverzahnung)

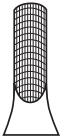

Wichtige Information zur Bestellung von Zahnzangen:

Sie finden auf den nachfolgenden Seiten unsere Zahnzangen sowohl mit Karogriff (Standard) als auch mit Fingerformgriff (Anatomisch). Bei den Zahnzangen mit zwei Bestellnummern haben Sie die Möglichkeit, auf jeder Katalogseite zwischen standard oder anatomischer Griffform zu wählen.

Beispiel:
Die Zahnzangen mit Karogriff (Standard) bestellen Sie wie folgt:

Standard Ref. 11-...



Möchten Sie die gleiche (oder eine andere Zahnzange) in Fingerform (Anatomisch) bestellen Sie wie folgt:

Anatomisch Ref. 12-...



Wir liefern - außer der Amerikanischen Zangenform - alle Zahnzangen mit Haftprofil und Teflonscheibe in den Arbeitsschanieren.

Important instruction for the order of forceps:

All extracting forceps are cross serrated in inside of jaws.

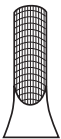

Please find our Extracting-forceps with grain handles (standard) and fingerform handle (anatomic) on the following pages. Furthermore, we have marked our Extracting-forceps with two article numbers, which means you can choose between grain handle Ref.11-...(standard) and fingerform handle Ref.12-... (anatomic) of each forceps.

If you want to order grain handle (Standard)

Standard Ref. 11-...



If you want to order fingerform (anatomic)

Anatomic Ref. 12...

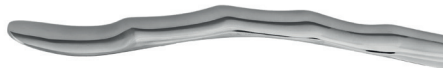

All our Extracting-forceps are set upped with teflon disks between the joint and they are serrated inside of jaws, except american-pattern.



Bestell-Nr.
Order-No.

OK-Schneidezähne upper centrals / caines

Ref. 11-1
Ref. 12-1

Griff / Handle:
Standard
Anatomisch

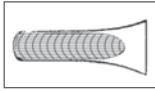

Fig. 1 (Abb. Griff Standard)

OK-Schneidezähne upper centrals / caines

Ref. 11-2
Ref. 12-2

Griff / Handle:
Standard
Anatomisch

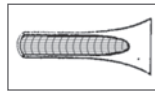

Fig. 2 (Abb. Griff Standard)

OK-Prämolaren upper premolars

Ref. 11-7
Ref. 12-7

Griff / Handle:
Standard
Anatomisch

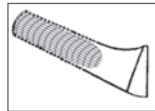

Fig. 7 (Abb. Griff Standard)

OK-Molaren rechts upper molars right

Ref. 11-17
Ref. 12-17

Griff / Handle:
Standard
Anatomisch

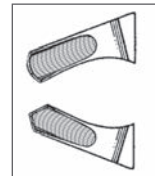

Fig. 17 (Abb. Griff Standard)

OK-Molaren links upper molars left

Ref. 11-18
Ref. 12-18

Griff / Handle:
Standard
Anatomisch

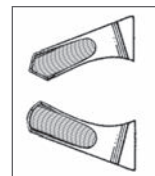

Fig. 18 (Abb. Griff Standard)

UK-Prämolaren lower premolars



Fig. 13 (Abb. Griff Standard)

Griff / Handle:
Standard
Anatomisch

Ref. 11-13
Ref. 12-13

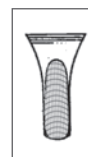

UK-Wurzeln lower roots



Fig. 33 (Abb. Griff Standard)

Griff / Handle:
Standard
Anatomisch

Ref. 11-33
Ref. 12-33

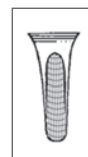

UK-Wurzeln lower roots



Fig. 33A (Abb. Griff Standard)

Griff / Handle:
Standard
Anatomisch

Ref. 11-33A
Ref. 12-33A

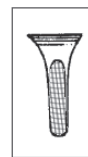

UK-Molar lower molars



Fig. 22 (Abb. Griff Standard)

Griff / Handle:
Standard
Anatomisch

Ref. 11-22
Ref. 12-22



UK-dritte Molare lower third molars



Fig. 79 (Abb. Griff Standard)

Griff / Handle:
Standard
Anatomisch

Ref. 11-79
Ref. 12-79

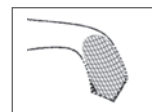

Bestell-Nr.
Order-No.

OK-Molaren links & rechts upper molars left & right

Ref. 11-18A
Ref. 12-18A

Griff / Handle:
Standard
Anatomisch

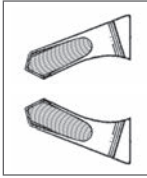

Fig. 18A (Abb. Griff Standard)

OK-Wurzeln upper roots

Ref. 11-51
Ref. 12-51

Griff / Handle:
Standard
Anatomisch

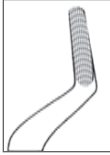

Fig. 51 (Abb. Griff Standard)

OK-Wurzeln upper roots

Ref. 11-51A
Ref. 12-51A

Griff / Handle:
Standard
Anatomisch

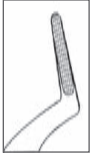

Fig. 51A (Abb. Griff Standard)

OK-dritte Molaren upper third molars

Ref. 11-67A
Ref. 12-67A

Griff / Handle:
Standard
Anatomisch

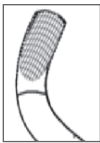

Fig. 67A (Abb. Griff Standard)

OK-Wurzeln upper roots

Ref. 11-29
Ref. 12-29

Griff / Handle:
Standard
Anatomisch

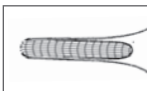

Fig. 29 (Abb. Griff Standard)

UK-Molar lower molars



Fig. 73 (Abb. Griff Standard)

Griff / Handle:
Standard
Anatomisch

Ref. 11-73
Ref. 12-73

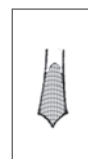

UK-Wurzeln lower roots



Fig. 74 (Abb. Griff Standard)

Griff / Handle:
Standard
Anatomisch

Ref. 11-74
Ref. 12-74

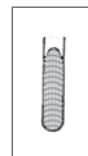

UK-Wurzeln lower roots



Fig. 74N (Abb. Griff Standard)

Griff / Handle:
Standard
Anatomisch

Ref. 11-74N
Ref. 12-74N

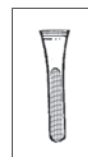

UK-Prämolaren lower premolars



Fig. 75 (Abb. Griff Standard)

Griff / Handle:
Standard
Anatomisch

Ref. 11-75
Ref. 12-75

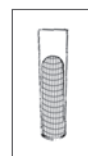

UK-Frontzähne lower incisors / canines



Fig. 4 (Abb. Griff Standard)

Griff / Handle:
Standard
Anatomisch

Ref. 11-4
Ref. 12-4

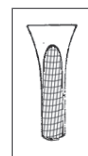

Bestell-Nr.
Order-No.

OK-Wurzeln upper roots

Ref. 11-29N
Ref. 12-29N

Griff / Handle:
Standard
Anatomisch

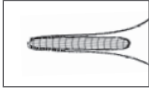

Fig. 29N (Abb. Griff Standard)

OK-Wurzeln upper roots

Ref. 11-30
Ref. 12-30

Griff / Handle:
Standard
Anatomisch

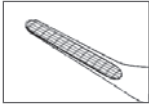

Fig. 30 (Abb. Griff Anatomisch)

OK-Molaren rechts upper molars right

Ref. 11-89
Ref. 12-89

Griff / Handle:
Standard
Anatomisch

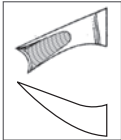

Fig. 89 (Abb. Griff Anatomisch)

OK-Molaren links upper molars left

Ref. 11-90
Ref. 12-90

Griff / Handle:
Standard
Anatomisch

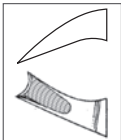

Fig. 90 (Abb. Griff Anatomisch)

OK-Wurzeln upper roots

Ref. 11-501
Ref. 12-501

Griff / Handle:
Standard
Anatomisch

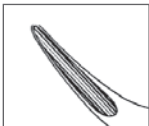

Fig. 501 (Abb. Griff Anatomisch)

UK-Wurzeln lower roots

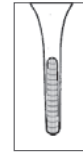

Fig. 33M (Abb. Griff Standard)

Griff / Handle:

- Standard
- Anatomisch

- Ref. 11-33M
- Ref. 12-33M



UK-Molaren rechts lower molars right



Fig. 23 (Abb. Griff Standard)

Griff / Handle:

- Standard
- Anatomisch

- Ref. 11-23
- Ref. 12-23

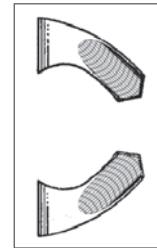

Fig. 24 (Abb. Griff Standard)

Griff / Handle:

- Standard
- Anatomisch

- Ref. 11-24
- Ref. 12-24

UK-Molaren links lower molars left

UK-Molaren lower molars

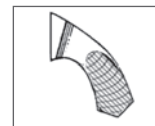

Fig. 21 (Abb. Griff Standard)

Griff / Handle:

- Standard
- Anatomisch

- Ref. 11-21
- Ref. 12-21



UK-Wurzelsplitterzange lower roots fragment

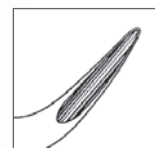

Fig. 502 (Abb. Griff Standard)

Griff / Handle:

- Standard
- Anatomisch

- Ref. 11-502
- Ref. 12-502



Bestell-Nr.
Order-No.

OK-Wurzeln upper roots

Ref. 11-51K
Ref. 12-51K

Griff / Handle:
Standard
Anatomisch

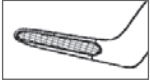

Fig. 51K (Abb. Griff Standard)

OK-Wurzeln upper roots

Ref. 11-51M
Ref. 12-51M

Griff / Handle:
Standard
Anatomisch

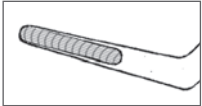

Fig. 51M (Abb. Griff Standard)

OK-Universalzange upper universal forceps

Ref. 11-62
Ref. 12-62

Griff / Handle:
Standard
Anatomisch

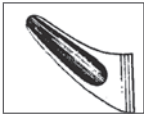

Fig. 62 (Abb. Griff Standard)

OK+UK Wurzelsplitterzange upper & lower fragements

Ref. 11-69
Ref. 12-69

Griff / Handle:
Standard
Anatomisch

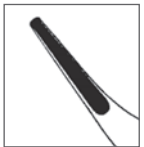

Fig. 69 (Abb. Griff Standard)

OK-Wurzeln upper roots

Ref. 11-151
Ref. 12-151

Griff / Handle:
Standard
Anatomisch

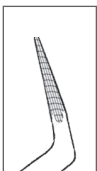

Fig. 151 (Abb. Griff Standard)

UK-Prämolare lower prämolars



Fig. 8 (Abb. Griff Standard)

Griff / Handle:
Standard
Anatomisch

Ref. 11-8
Ref. 12-8

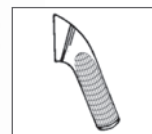

UK-Molaren lower molars



Fig. 86A (Abb. Griff Standard)

Griff / Handle:
Standard
Anatomisch

Ref. 11-86A
Ref. 12-86A

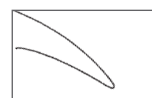

UK-Molaren lower molars



Fig. 86C (Abb. Griff Standard)

Griff / Handle:
Standard
Anatomisch

Ref. 11-86C
Ref. 12-86C



UK-Wurzeln lower roots



Fig. 136 (Abb. Griff Standard)

Griff / Handle:
Standard
Anatomisch

Ref. 11-136
Ref. 12-136

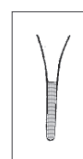

UK-Wurzeln lower roots



Fig. 145 (Abb. Griff Standard)

Griff / Handle:
Standard
Anatomisch

Ref. 11-145
Ref. 12-145

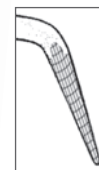

Bestell-Nr.
Order-No.

OK-Wurzeln upper roots

Ref. 11-152
Ref. 12-152

Griff / Handle:
Standard
Anatomisch



Fig. 152 (Abb. Griff Standard)

OK-Wurzeln upper roots sehr fein ultra fine

Ref. 11-49
Ref. 12-49

Griff / Handle:
Standard
Anatomisch

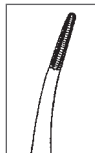

Fig. 49 (Abb. Griff Standard)

UK-Wurzeln lower roots

Ref. 11-45
Ref. 12-45

Griff / Handle:
Standard
Anatomisch



Fig. 45 (Abb. Griff Standard)

UK-Wurzeln lower roots

Ref. 11-31
Ref. 12-31

Griff / Handle:
Standard
Anatomisch

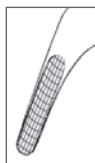

Fig. 31 (Abb. Griff Standard)

UK-Wurzeln lower roots sehr fein ultra fine

Ref. 11-46
Ref. 12-46

Griff / Handle:
Standard
Anatomisch



Fig. 46 (Abb. Griff Standard)

OK-Kronenabnehmerzange upper crown remover



Fig. 01 (Abb. Griff Anatomisch)

Griff / Handle:
Anatomisch

Ref. 12-101

UK-Kronenabnehmerzange lower crown remover

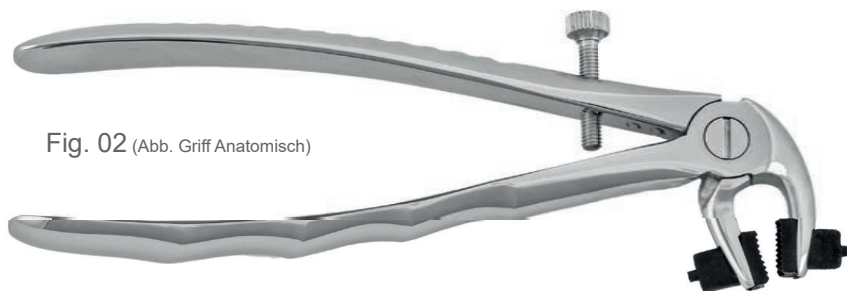

Fig. 02 (Abb. Griff Anatomisch)

Griff / Handle:
Anatomisch

Ref. 12-102

OK-Kronenabnehmerzange upper crown remover



Fig. 03 (Abb. Griff Anatomisch)

Griff / Handle:
Anatomisch

Ref. 12-103



UK-Kronenabnehmerzange lower crown remover



Fig. 04 (Abb. Griff Anatomisch)

Griff / Handle:
Anatomisch

Ref. 12-104



Kronenabnehmerzange crown remover



Ref. 12-105A
Einsätze paarweise

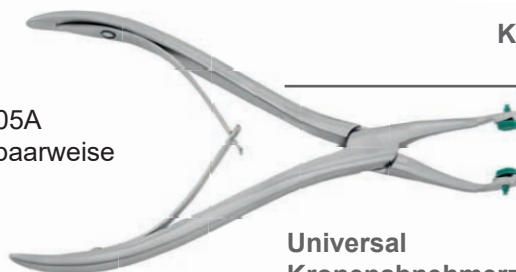

Griff / Handle:
Anatomisch
Kunststoffbacken sind austauschbar

Ref. 12-105

Universal Kronenabnehmerzange crown remover



gebogen

Griff / Handle:
Anatomisch

Ref. 12-106

Bestell-Nr.
Order-No.

UK-Molaren & Weisheitszähne links lower molars & wisdoms left

Ref. 11-122L
Ref. 12-122L

Griff / Handle:
Standard
Anatomisch

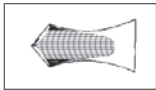

Fig. 122L (Abb. Griff Standard)

UK-Molaren & Weisheitszähne rechts lower molars & wisdoms right

Ref. 11-122R
Ref. 12-122R

Griff / Handle:
Standard
Anatomisch

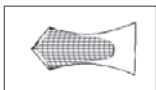

Fig. 122R (Abb. Griff Standard)

UK-Molaren lower molars

Ref. 12-186L

Griff / Handle:
Anatomisch



Fig. 186L (Abb. Griff Anatomisch)

UK-Molaren lower molars

Ref. 12-186R

Griff / Handle:
Anatomisch



Fig. 186R (Abb. Griff Anatomisch)

Tiefgreifende Wurzelzangen

Deep gripping root forceps

Bestell-Nr.
Order-No.

OK-Wurzeln upper roots



Fig. 153 (Abb. Griff Standard)

Griff / Handle:
Standard
Anatomisch

Ref. 11-153
Ref. 12-153

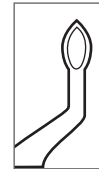

UK-Wurzeln lower roots



Fig. 146 (Abb. Griff Standard)

Griff / Handle:
Standard
Anatomisch

Ref. 11-146
Ref. 12-146

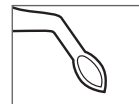

OK-Wurzeln upper roots



Fig. 149 (Abb. Griff Standard)

Griff / Handle:
Standard
Anatomisch

Ref. 11-149
Ref. 12-149

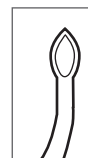

OK-Schneidezähne upper centrals / cains



Fig. 34A (Abb. Griff Standard)

Griff / Handle:
Standard
Anatomisch

Ref. 11-34A
Ref. 12-34A

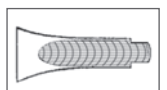

Bestell-Nr.
Order-No.

OK-Prämolaren upper premolars

Ref. 11-35A
Ref. 12-35A

Griff / Handle:
Standard
Anatomisch

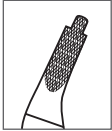

Fig. 35A (Abb. Griff Standard)

OK-Wurzeln upper roots

Ref. 11-331
Ref. 12-331

Griff / Handle:
Standard
Anatomisch

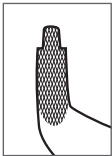

Fig. 331 (Abb. Griff Standard)

UK-Prämolaren lower premolar

Ref. 11-336
Ref. 12-336

Griff / Handle:
Standard
Anatomisch

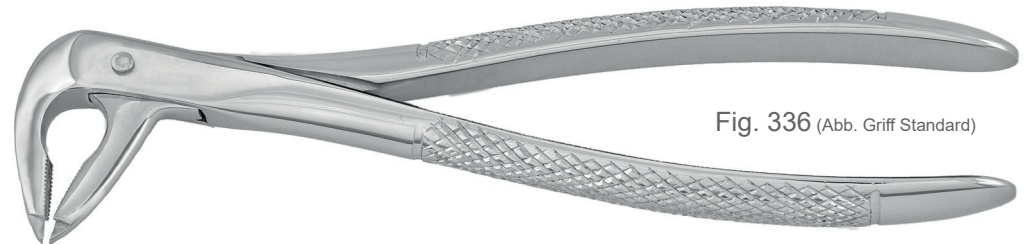
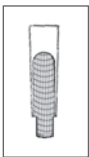

Fig. 336 (Abb. Griff Standard)

UK-Prämolaren lower premolar

Ref. 11-36A
Ref. 12-36A

Griff / Handle:
Standard
Anatomisch

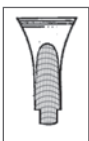

Fig. 36A (Abb. Griff Standard)

OK-dritte molaren upper third molars

Griff / Handle:
Standard
Anatomisch

Ref. 11-67N
Ref. 12-67N

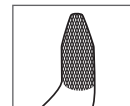

Fig. 67N (Abb. Griff Anatomisch)

UK-dritte molaren lower third molars

Griff / Handle:
Standard
Anatomisch

Ref. 11-79N
Ref. 12-79N

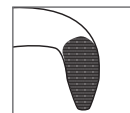

Fig. 79N (Abb. Griff Anatomisch)

OK-Prämolaren upper premolars

Griff / Handle:
Standard
Anatomisch

Ref. 11-7N
Ref. 12-7N

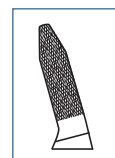

Fig. 7N (Abb. Griff Anatomisch)

UK-Prämolaren lower premolars

Griff / Handle:
Standard
Anatomisch

Ref. 11-36N
Ref. 12-36N

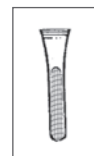

Fig. 36N (Abb. Griff Anatomisch)

Bestell-Nr.
Order-No.

OK-Schneidezähne upper incisors

Ref. 11-37

Griff / Handle:
Standard

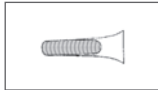

Fig. 37 (Abb. Griff Standard)

OK-Wurzeln upper roots

Ref. 11-29S

Griff / Handle:
Standard

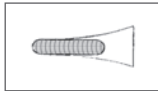

Fig. 29S (Abb. Griff Standard)

OK-Wurzeln upper roots

Ref. 11-30S

Griff / Handle:
Standard

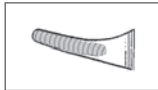

Fig. 30S (Abb. Griff Standard)

OK-Prämolaren upper premolars

Ref. 11-39

Griff / Handle:
Standard

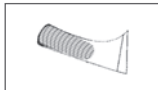

Fig. 39 (Abb. Griff Standard)

OK-Molaren upper molars

Ref. 11-39A

Griff / Handle:
Standard

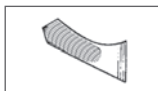

Fig. 39A (Abb. Griff Standard)

OK-Molaren rechts upper molars right

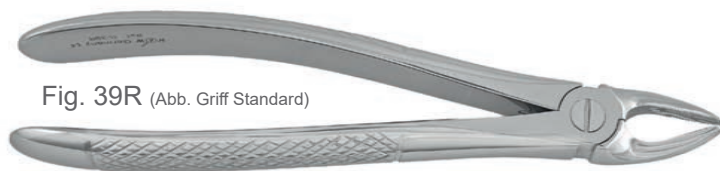
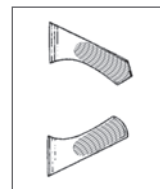

Fig. 39R (Abb. Griff Standard)

Griff / Handle:
Standard



Ref. 11-39R

OK-Molaren links upper molars left



Fig. 39L (Abb. Griff Standard)

Griff / Handle:
Standard



Ref. 11-39L

OK-Wurzeln upper roots



Fig. 51S (Abb. Griff Standard)

Griff / Handle:
Standard

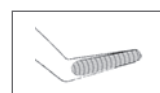

Ref. 11-51S

UK-Wurzeln lower roots

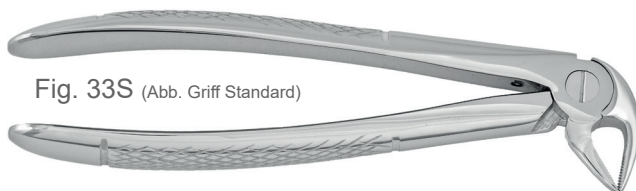
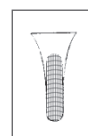

Fig. 33S (Abb. Griff Standard)

Griff / Handle:
Standard



Ref. 11-33S

Bestell-Nr.
Order-No.

UK-Prämolaren lower premolars

Ref. 11-13S

Griff / Handle:
Standard



Fig. 13S (Abb. Griff Standard)

UK-Molaren lower molars

Ref. 11-22S

Griff / Handle:
Standard

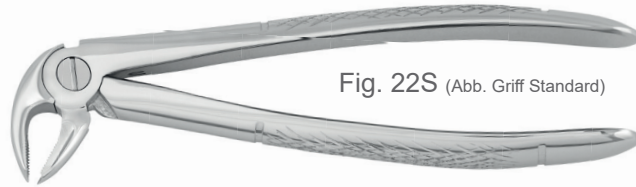

Fig. 22S (Abb. Griff Standard)

UK-Schneide- & Eckzähne lower incisors & canines

Ref. 11-38

Griff / Handle:
Standard

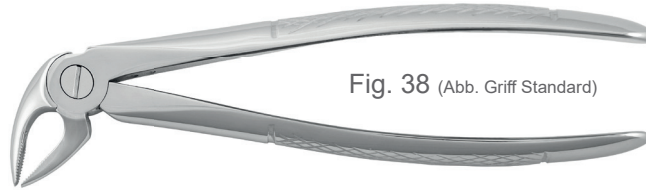
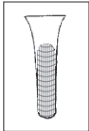

Fig. 38 (Abb. Griff Standard)

UK-Molaren lower molars

Ref. 11-40

Griff / Handle:
Standard



Fig. 40 (Abb. Griff Standard)

OK-Wurzeln upper roots

Ref. 11-76S

Griff / Handle:
Standard

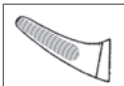

Fig. 76S (Abb. Griff Standard)

UK-Schneidezähne lower incisors

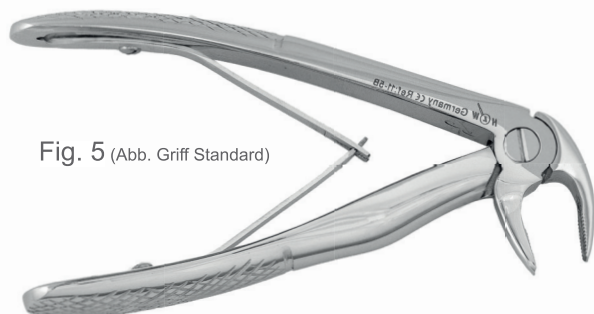

Fig. 5 (Abb. Griff Standard)

Griff / Handle:
Standard
Anatomisch

Ref. 11-5B
Ref. 12-5B

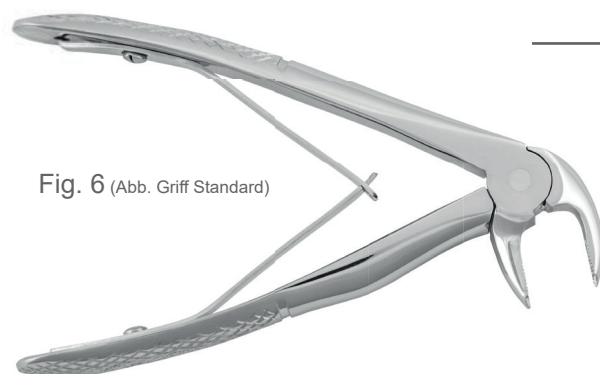

Fig. 6 (Abb. Griff Standard)

UK-Molaren lower molars

Griff / Handle:
Standard
Anatomisch

Ref. 11-6B
Ref. 12-6B

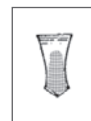
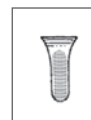

Fig. 7 (Abb. Griff Standard)

UK-Wurzeln lower roots

Griff / Handle:
Standard
Anatomisch

Ref. 11-7B
Ref. 12-7B



Bestell-Nr.
Order-No.

OK-Schneidezähne upper incisors

Ref. 11-137B
Ref. 12-137B

Griff / Handle:
Standard
Anatomisch

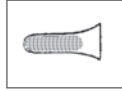

Fig. 137 (Abb. Griff Standard)

OK-Prämolaren upper premolars

Ref. 11-139B
Ref. 12-139B

Griff / Handle:
Standard
Anatomisch

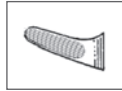

Fig. 139 (Abb. Griff Standard)

OK-Wurzeln upper roots

Ref. 11-51SB
Ref. 12-51SB

Griff / Handle:
Standard
Anatomisch

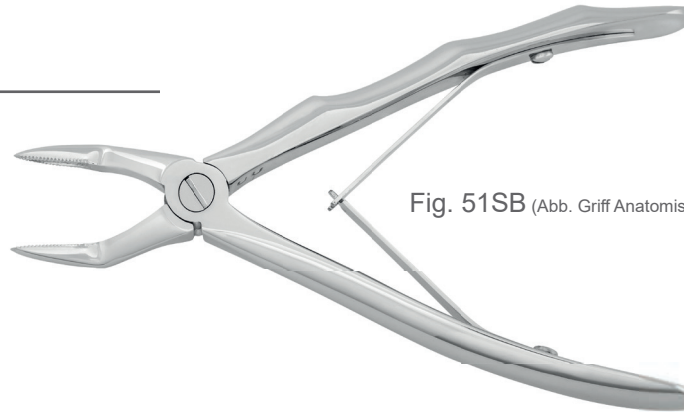
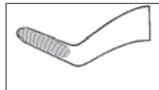

Fig. 51SB (Abb. Griff Anatomisch)

OK-Molaren upper molars

Ref. 11-3B
Ref. 12-3B

Griff / Handle:
Standard
Anatomisch

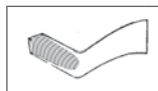

Fig. 3 (Abb. Griff Standard)

Wurzelheber Root Elevators



Luxierer Apical

Luxierer Fingerform

Luxierer LONG-TYPE

**Wurzelspitzenzangen
Root Fragment Forceps**

Wurzelsplitterheber

**Syndesmotome -
Chompret**

**Microtools
Atraumatic
Extraktions-Set**

Bestell-Nr.
Order-No.

Lecluse

Ref. 13-1



Winter

Ref. 13-11R

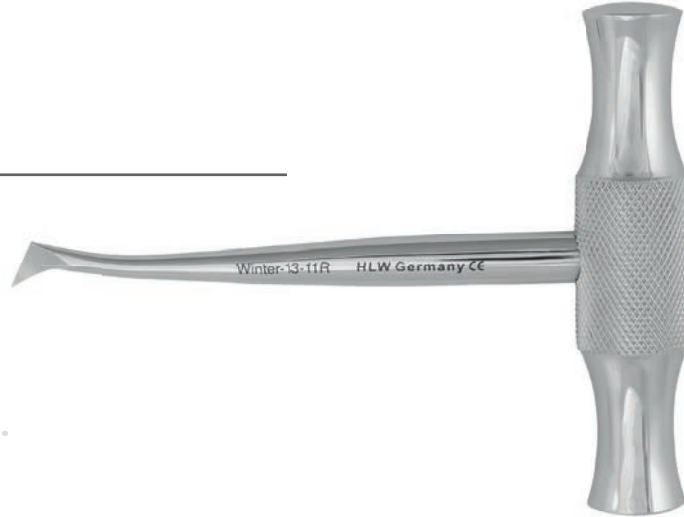
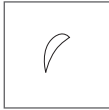

Ref. 13-11L

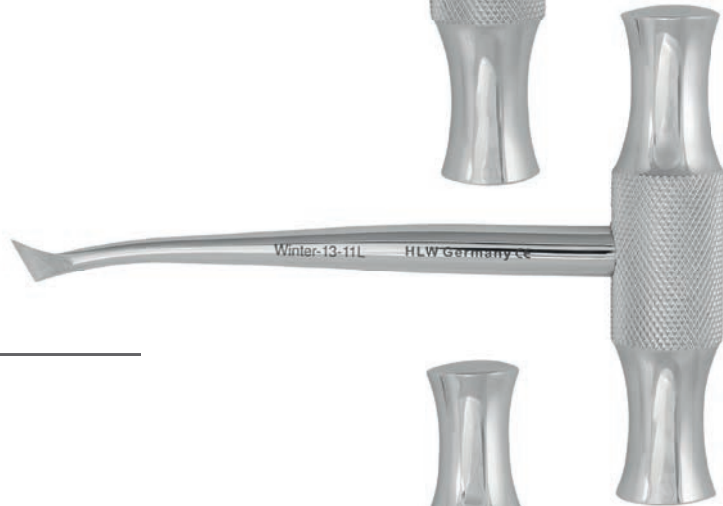

Winter

Ref. 13-12R

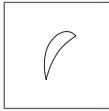

Ref. 13-12L

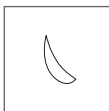

Winter

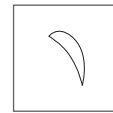
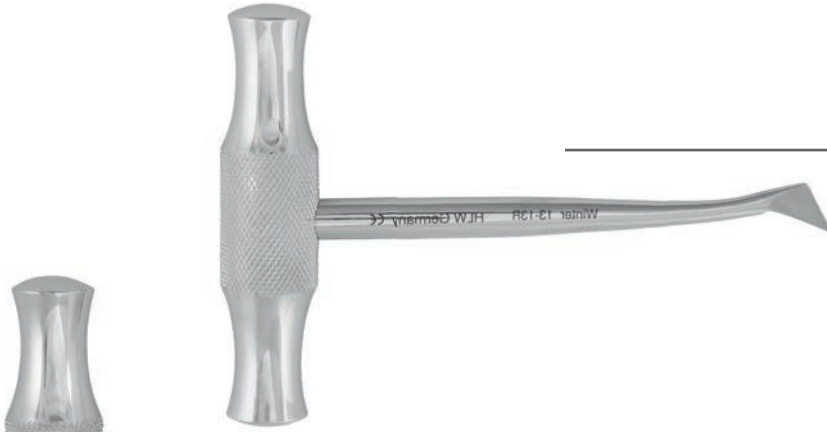

Ref. 13-13L

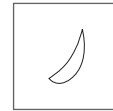

Ref. 13-13R

Winter

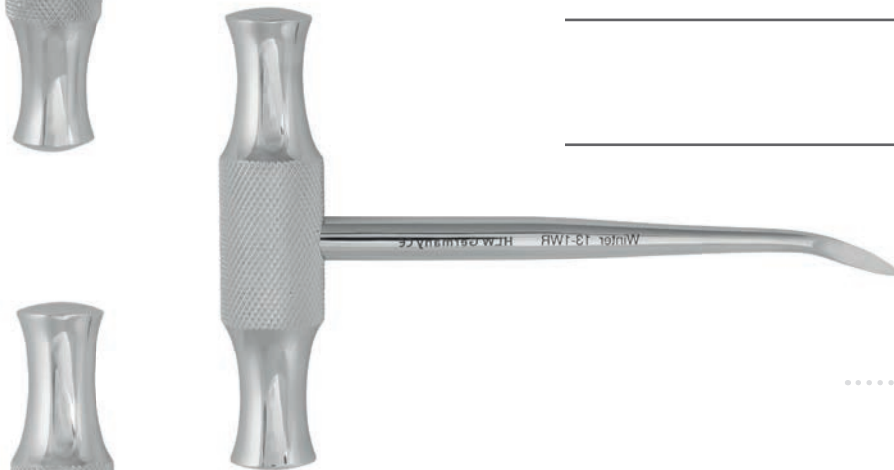

Ref. 13-1WL



Ref. 13-1WR

Winter

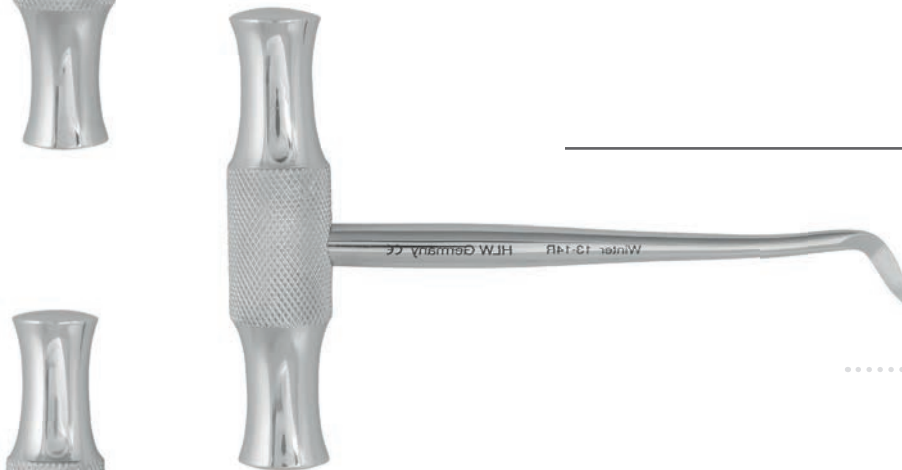

Ref. 13-14L

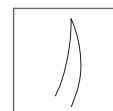

Ref. 13-14R

Bestell-Nr.
Order-No.

Krallenheber

Ref. 13-10R



Ref. 13-10L

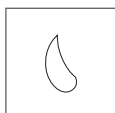

Flohr

Ref. 13-1F

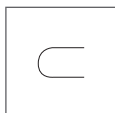

Flohr

Ref. 13-3F



Ref. 13-2F

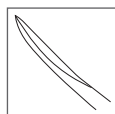

Friedmann



3,0 mm

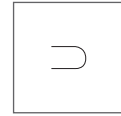

Ref. 13-4F

Friedmann



3,0 mm

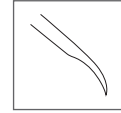

Ref. 13-5F



3,0 mm

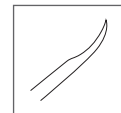

Ref. 13-6F

Pott



2,5 mm

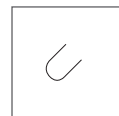

Ref. 13-1P

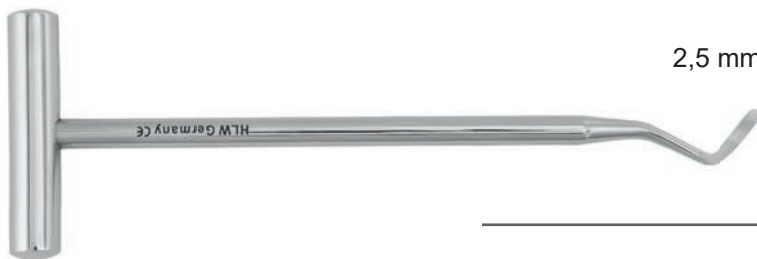

2,5 mm

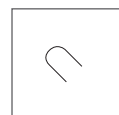

Ref. 13-2P

Bestell-Nr.
Order-No.

Heidbrink

Ref. 13-7H

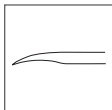

2,5 mm

Heidbrink

Ref. 13-9H



2,5 mm

2,5 mm

Ref. 13-8H

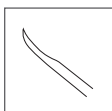

Heidbrink

Ref. 13-7HB

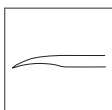

2,5 mm

Heidbrink

Ref. 13-9HB

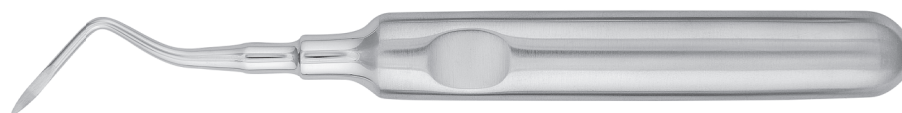

2,5 mm

2,5 mm

Ref. 13-8HB

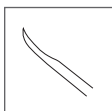

Cryer

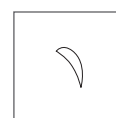

Ref. 13-27S



Ref. 13-28S

Cryer

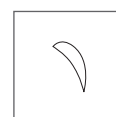

Ref. 13-27

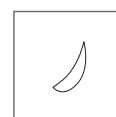

Ref. 13-28

Cryer

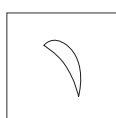

Ref. 13-31

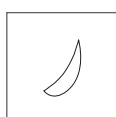

Ref. 13-32

Bestell-Nr.
Order-No.

Seldin

Ref. 13-4R



Ref. 13-4L

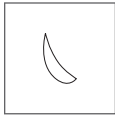

Seldin

Ref. 13-1R



Ref. 13-1L

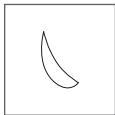

Warwick

Ref. 13-17



Warwick

Ref. 13-17R



Warwick

Ref. 13-17L



Hyllin



3,0 mm

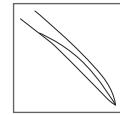

Ref. 13-30



3,0 mm

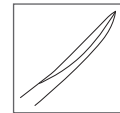

Ref. 13-40

Hyllin



3,0 mm

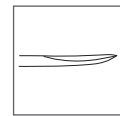

Ref. 13-10



4,5 mm

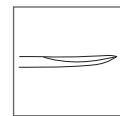

Ref. 13-20

Bein



2,0 mm



gerade / straight Ref. 13-01B

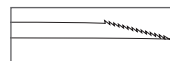

gezahnt / serrated Ref. 13-01BZ



gebogen / curved Ref. 13-01BC

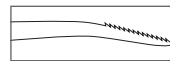

gezahnt / serrated Ref. 13-01BCZ

Bestell-Nr.
Order-No.

Bein

3,0 mm

Ref. 13-1B gerade / straight



Ref. 13-1BZ gezahnt / serrated



Ref. 13-1BC gebogen / curved



Ref. 13-1BCZ gezahnt / serrated



Bein

4,0 mm

Ref. 13-2B gerade / straight



Ref. 13-2BZ gezahnt / serrated

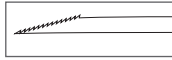

Ref. 13-2BC gebogen / curved



Ref. 13-2BCZ gezahnt / serrated



Bein

2,0 mm

Ref. 13-3B gerade / straight



Ref. 13-3BZ gezahnt / serrated

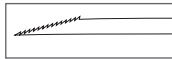

Ref. 13-3BC gebogen / curved

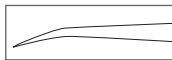

Ref. 13-3BCZ gezahnt / serrated

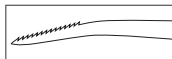

Bein

3,0 mm

Ref. 13-4B gerade / straight



Ref. 13-4BZ gezahnt / serrated

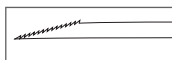

Ref. 13-4BC gebogen / curved



Ref. 13-4BCZ gezahnt / serrated





4,0 mm



gerade / straight Ref. 13-5B

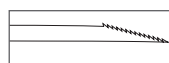

gezahnt / serrated Ref. 13-5BZ



gebogen / curved Ref. 13-5BC



gezahnt / serrated Ref. 13-5BCZ

Bein



2,0 mm



gerade / straight Ref. 13-6B

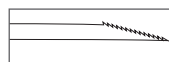

gezahnt / serrated Ref. 13-6BZ



gebogen / curved Ref. 13-6BC

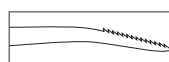

gezahnt / serrated Ref. 13-6BCZ

Bein



3,0 mm



gerade / straight Ref. 13-7B

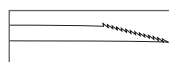

gezahnt / serrated Ref. 13-7BZ



gebogen / curved Ref. 13-7BC

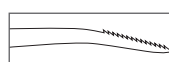

gezahnt / serrated Ref. 13-7BCZ

Bein



4,0 mm



gerade / straight Ref. 13-8B



gezahnt / serrated Ref. 13-8BZ



gebogen / curved Ref. 13-8BC

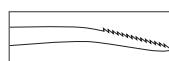

gezahnt / serrated Ref. 13-8BCZ

Bein

Bestell-Nr.
Order-No.

8er Heber

Ref. 13-81

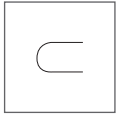

4,0 mm Bajonett distal



8er Heber

Ref. 13-82

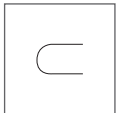

4,0 mm Bajonett mesial



Bein

Ref. 13-9B

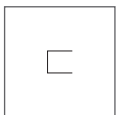

3,0 mm Bajonett



Bein

Ref. 13-10B

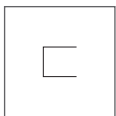

4,0 mm Bajonett



Coleman



4,0 mm

Ref. 13-100

London Hospital



4,0 mm

Ref. 13-101



4,0 mm

Ref. 13-102

Berten



Ref. 13-4

7,0 mm

13,0 mm

Ref. 13-4A

5,0 mm

10,0 mm

Kopp



3,0 mm

Ref. 13-1K



3,0 mm

Ref. 13-2K



Bestell-Nr.
Order-No.

Apical

Ref. 13-301

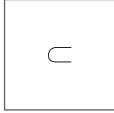

2,0 mm



Apical

Ref. 13-303

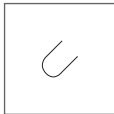

3,0 mm



Ref. 13-302

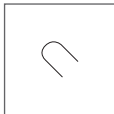

3,0 mm



Apical

Ref. 13-304

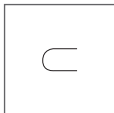

3,0 mm



Seldin

Ref. 13-3

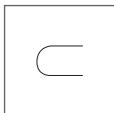

4,0 mm



Cryer

Ref. 13-3A

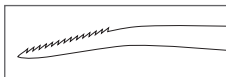

4,5 mm





gerade / straight



Ref. 13-70

3,0 mm



gebogen / curved



Ref. 13-71

3,0 mm



bajonett

Ref. 13-72

4,0 mm



links / left

Ref. 13-73L

3,0 mm



rechts / right

Ref. 13-73R

3,0 mm

Bestell-Nr.
Order-No.

Ref. 13-1LX



2,0 mm gerade / straight

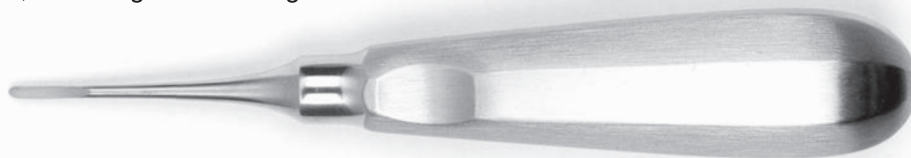

Ref. 13-5LX



2,0 mm gebogen / curved



Ref. 13-2LX



3,0 mm gerade / straight

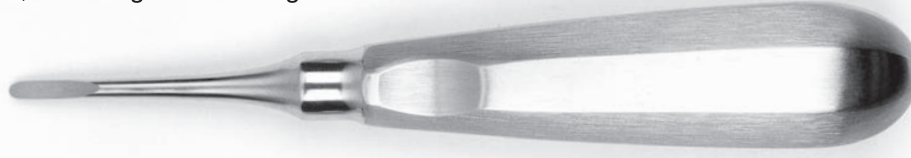

Ref. 13-6LX



3,0 mm gebogen / curved



Ref. 13-3LX



4,0 mm gerade / straight

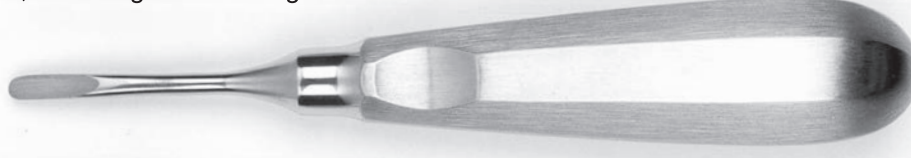

Ref. 13-7LX



4,0 mm gebogen / curved



Ref. 13-4LX



5,0 mm gerade / straight

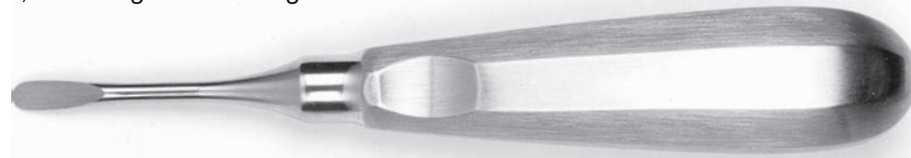

Ref. 13-8LX



5,0 mm gebogen / curved

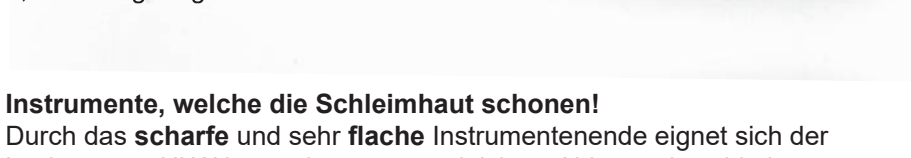





Instrumente, welche die Schleimhaut schonen!

Durch das **scharfe** und sehr **flache** Instrumentenende eignet sich der Luxierer von HLW besonders gut zum leichten Ablösen des zirkulären Ligaments. Eine Extraktion ist somit gingivaschonend möglich.

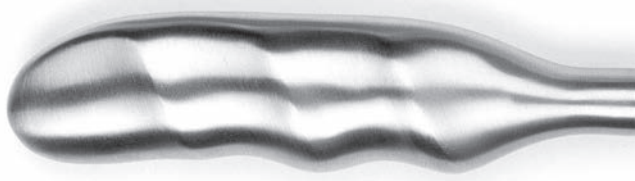
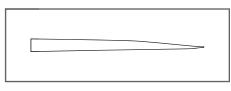
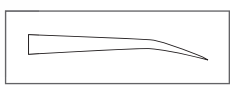
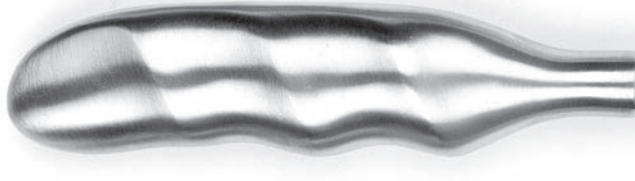
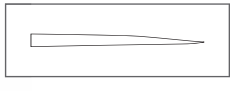
Luxierer Fingerform

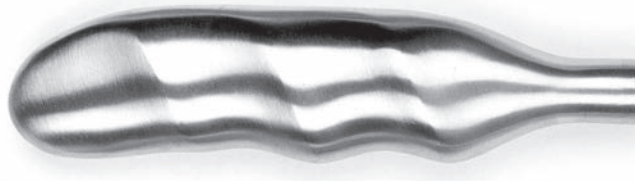
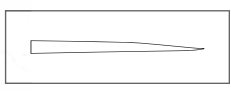
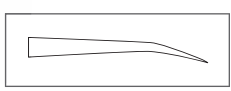
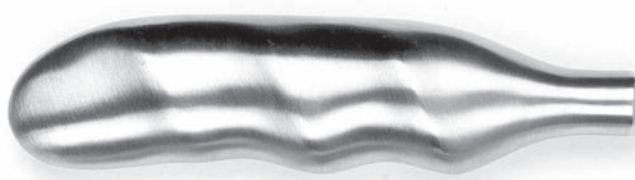
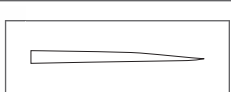
Bestell-Nr.
Order-No.

	gerade / straight	2,0 mm		Ref. 13-9LX
	gebogen / curved	2,0 mm		Ref. 13-13LX
	gerade / straight	3,0 mm		Ref. 13-10LX
	gebogen / curved	3,0 mm		Ref. 13-14LX
	gerade / straight	4,0 mm		Ref. 13-11LX
	gebogen / curved	4,0 mm		Ref. 13-15LX
	gerade / straight	5,0 mm		Ref. 13-12LX
	gebogen / curved	5,0 mm		Ref. 13-16LX

Instruments for the protection of mucous membrane.

The **sharp** and **flat** working tip of "Luxierer" is especially suitable for loosening of circular ligament. Subsequently the extraction is possible without hurt of mucous membrane.



Bestell-Nr.
Order-No.

Ref. 13-20LX  gerade / straight

1,5 mm

LONG-TYPE



Ref. 13-21LX  gerade / straight

2,0 mm

LONG-TYPE



Ref. 13-22LX  gerade / straight

3,0 mm

LONG-TYPE



Ref. 13-23LX  gerade / straight

5,0 mm

LONG-TYPE



Ref. 13-25LX  gebogen / curved

3,0 mm

LONG-TYPE



gebogen / curved



Ref. 13-26LX



nach oben geknickt / upper angled



Ref. 13-30LX



doppelt gewinkelt / double angled



Ref. 13-31LX



gerade / straight

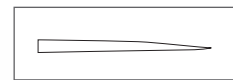

Ref. 13-35LX



gerade / straight



Ref. 13-36LX



Bestell-Nr.
Order-No.

Stieglitz

Ref. 13-50S



Stieglitz

Ref. 13-60S

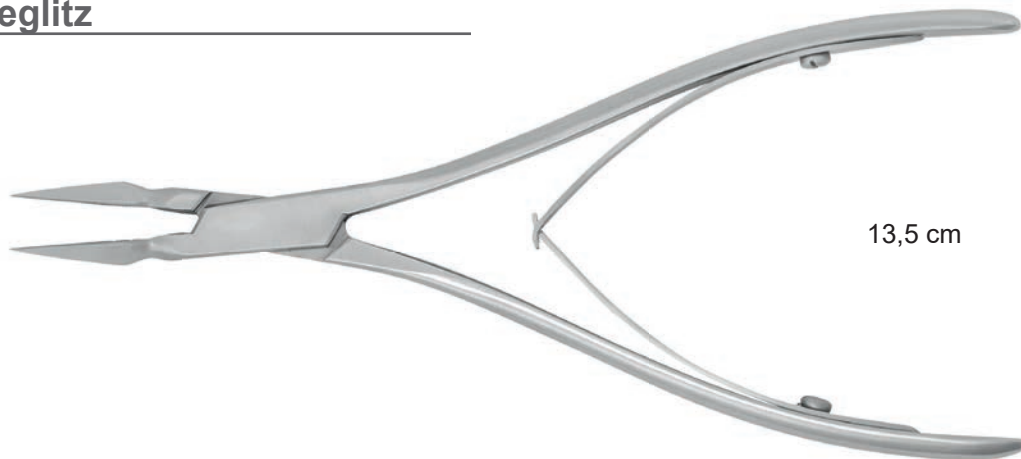

Universal

Ref. 13-75TC

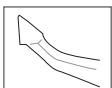

Wurzelsplitterheber

Bestell-Nr.
Order-No.

Heidbrink



Heidbrink



Heidbrink



Syndesmotome - Chompret



Im Zeitalter der Implantologie gilt die atraumatische Extraktion als Mittel der Wahl. Der Erhalt von Weich und Hartgewebe ist für die ästhetische Insertion von Implantaten zwingend notwendig.

Als erster Schritt gilt es die sharpeyschen Fasern zu durchtrennen. Mit dem Periotom PT02 umfahren Sie den Zahn auf Knocheniveau, danach stechen Sie mit den Periotom PT01 vestibulär und lingual/palatinal so tief es geht in den Parodontalspalt, ohne Knochenlamelle zu sprengen. Nun lassen Sie die Extraktionsstelle 5 min. Einbluten.

Eine Vielzahl der Zähne lässt sich jetzt bereits mit einer tiefgreifenden Zange, durch Luxation und Rotation entfernen.

Für alle Anderen kommen jetzt die Microtools 13-1 bis 13MT zum Einsatz.

Dabei werden zuerst die Pfeildesmotome 13-8 bis 11, zum weiteren Luxieren des Zahnes am Parodontalsplatt benutzt.

Alle anderen Instrumente dienen der weiteren atraumatischen Luxation des Zahnes.

Zur letztlichen Extraktion empfiehlt sich immer eine tiefgreifende Zange, unter besonderer Berücksichtigung der Weich und Hartgewebe.



Microtool gerade 2,5 mm Anwendung für den Frontbereich und Oberkiefer **Ref. 13-1MT**



Microtool gerade 3,5 mm Anwendung für den Frontbereich und Oberkiefer **Ref. 13-3MT**



Microtool gerade 4,5 mm Anwendung für den Frontbereich und Oberkiefer **Ref. 13-5MT**



Microtool gebogen 2,5 mm Anwendung für den Unterkiefer **Ref. 13-2MT**



Microtool gebogen 3,5 mm Anwendung für den Unterkiefer **Ref. 13-4MT**



Microtool gebogen 4,5 mm Anwendung für den Unterkiefer **Ref. 13-6MT**



Microtool gebogen 2,5 mm Anwendung für die distale Wurzelextraktion **Ref. 13-14MT**



Microtool gerade 3,0 mm Anwendung für den Frontbereich und Oberkiefer **Ref. 13-11MT**

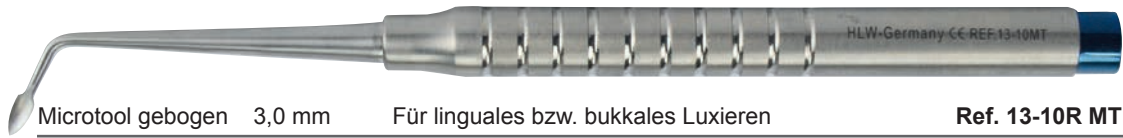

Microtool gebogen 3,0 mm Für linguales bzw. bukkales Luxieren **Ref. 13-10R MT**



Microtool gebogen 3,0 mm Für linguales bzw. bukkales Luxieren **Ref. 13-10L MT**



Microtool gebogen 3,0 mm Anwendung für den mesialen Bereich **Ref. 13-8MT**



Microtool gebogen 3,0 mm Anwendung für den distalen Bereich **Ref. 13-9MT**



Microtool gebogen 3,5 mm Anwendung für die distale Wurzelextraktion **Ref. 13-15MT**



Microtool gebogen 4,5 mm Anwendung für die distale Wurzelextraktion **Ref. 13-17MT**



Microtool gebogen 3,5 mm Anwendung für die mesiale Wurzelextraktion **Ref. 13-16MT**



Microtool gebogen 4,5 mm Anwendung für die mesiale Wurzelextraktion **Ref. 13-18MT**

Hohlmeißelzangen
Bone Rongeur

Gewebezangen
Gingival Tissue Cutter





3,0 mm

Mini-Friedmann
Ref. 14-1 / 12,0 cm

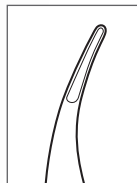

2,0 mm
S-Form

Micro-Friedmann
Ref. 14-2 / 16,0 cm

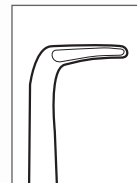

90° angled

Micro-Friedmann
Ref. 14-2B / 16,0 cm

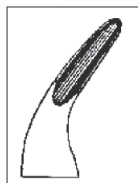

3,5 mm
45° angled

Blumenthal
Ref. 14-3 / 15,0 cm

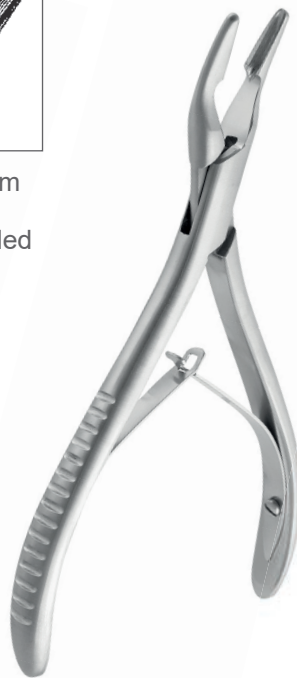

3,0 mm

Luer
Ref. 14-4 / 15,0 cm



4,0 mm

Luer
Ref. 14-5 / 15,0 cm

Bestell-Nr.
Order-No.

Gewebezange Gingival tissue cutter

Ref. 14-10 / 15,0 cm



Gewebezange spitz Gingival tissue cutter

Ref. 14-11 / 15,0 cm



Mundspretzer

Mouth Gags

Gewebezangen

Gingival Tissue Cutter

Amalgampistole

Hammer

Haltezangen

Waschtray

Wash Tray

Waschkörbe

Mesh Baskets

Instrumentenschalen

Trays

Kronenentferner

Crown Remover

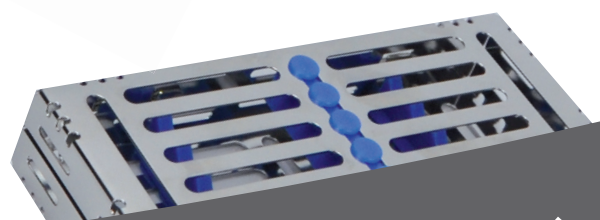
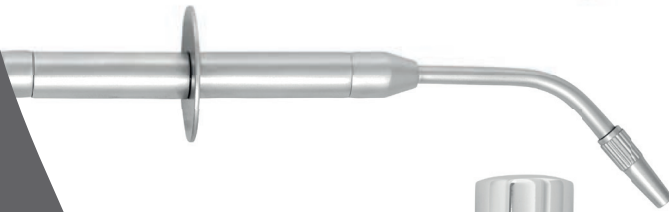

Bestell-Nr.
Order-No.

Mundspretzer Mouth Gags

Ref. 15-1



Mundspretzer Mouth Gags

Ref. 15-4

nach Molt



Mundspretzer Mouth Gags

Ref. 15-4A

nach Denhart



Mundspretzer Mouth Gags

Ref. 15-4B

nach Ivory



Wangenhalter Retractor

Bestell-Nr.
Order-No.

Zungenspatel tonque depressor



Ref. 15-13A

nach BRUENINGS

19,0 cm

Wangenhalter Retractor



Ref. 15-14

21,0 cm

Wangenhalter Retractor



Ref. 15-14A

12,0 cm

Wangenhalter Retractor



Ref. 15-15

nach SENN



Ref. 15-15A

Mini LANGENBECK

16,0 cm

Wangenhalter Retractor



30,0 x 11,0 mm

Ref. 15-16

30,0 x 16,0 mm

Ref. 15-17

nach LANGENBECK

21,0 cm



Bestell-Nr.
Order-No.

Ref. 15-17A

30,0 x 16,0 mm



nach LANGENBECK

21,0 cm

Ref. 15-17B

42,0 x 11,0 mm



nach LANGENBECK

21,0 cm

Ref. 15-17C

60,0 x 12,0 mm

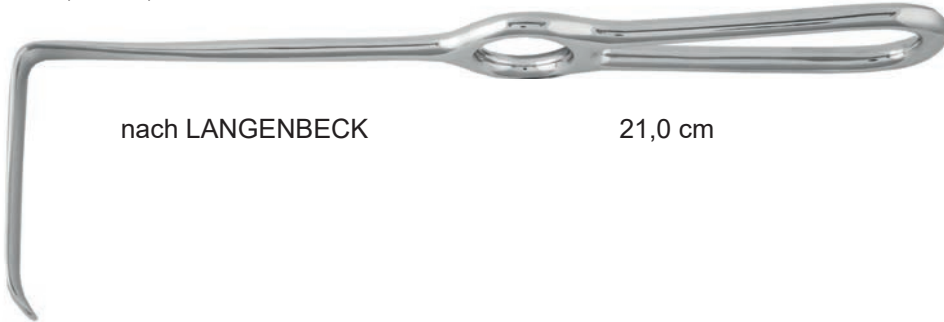

nach LANGENBECK

21,0 cm

Wangenhalter Retractor

Ref. 15-18



nach MIDDELDORF

21,0 cm

Wangenhalter Retractor



Ref. 15-23

16,0 cm nach MINNESOTA

Wangenhalter Retractor



Ref. 15-26

16,0 cm

Wangenhalter Retractor



Ref. 15-27

19,0 cm

Amalgampistole

Metall

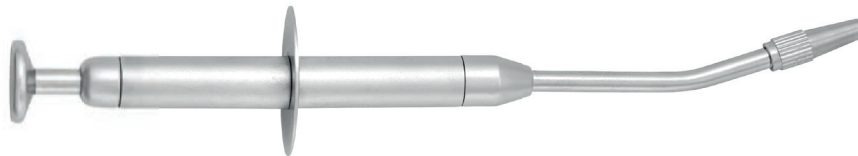

Ref. 16-1

Metall



Ref. 16-2

Metall



Ref. 16-3

Bestell-Nr.
Order-No.

Ref. 40-01



auswechselbare
Kunststoffbacken

Griff aus Edelstahl

18,5 cm, 200 g

Ref. 40-001



auswechselbare
Kunststoffbacken

Griff aus Edelstahl

18,5 cm, 200 g

Ref. 15-3



Bleihammer

16,0 cm, 200 g

Haltezangen

Spritzenhaltezange Syringe holding forceps

Ref. 15-11

20,0 cm

Ref. 15-12

30,0 cm



Schwammhaltezange Sponge holding forceps

Ref. 15-10

24,0 cm



Waschtray Wash Trays

Bestell-Nr.
Order-No.

- auswechselbare Silikoneinsätze in 4 Farben
- Silikoneinsätze verschiebbar
- abnehmbarer Verschlussdeckel

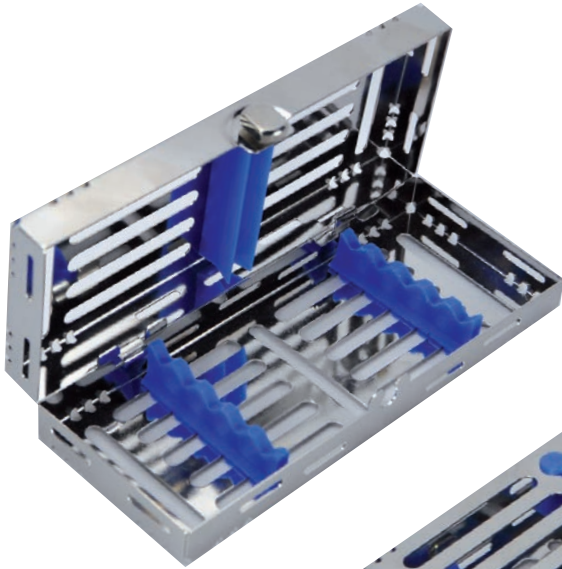

Edelstahltray
(5 Instrumente)

184,0 x 74,0 x 34,0 mm Ref. 15-51A
205,0 x 74,0 x 34,0 mm Ref. 15-51







Edelstahltray
(10 Instrumente)

205,0 x 145,0 x 34,0 mm Ref. 15-52



Silikoneinsätze für Wash Trays

wie abgebildet

Farben:	Orange		Ref. 15-50A
	Grün		Ref. 15-50B
	Gelb		Ref. 15-50C
	Blau		Ref. 15-50D

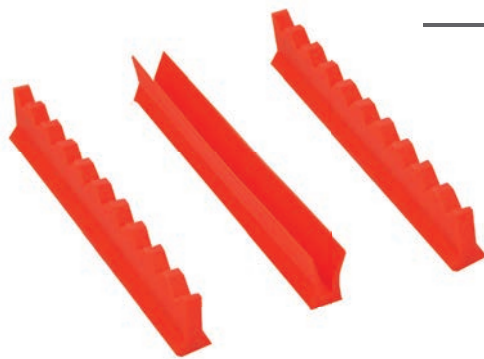

Bestell-Nr.
Order-No.

Edelstahltray (16 Instrumente + Ablagefach)

Ref. 15-53 280,0 x 183,0 x 32,0 mm

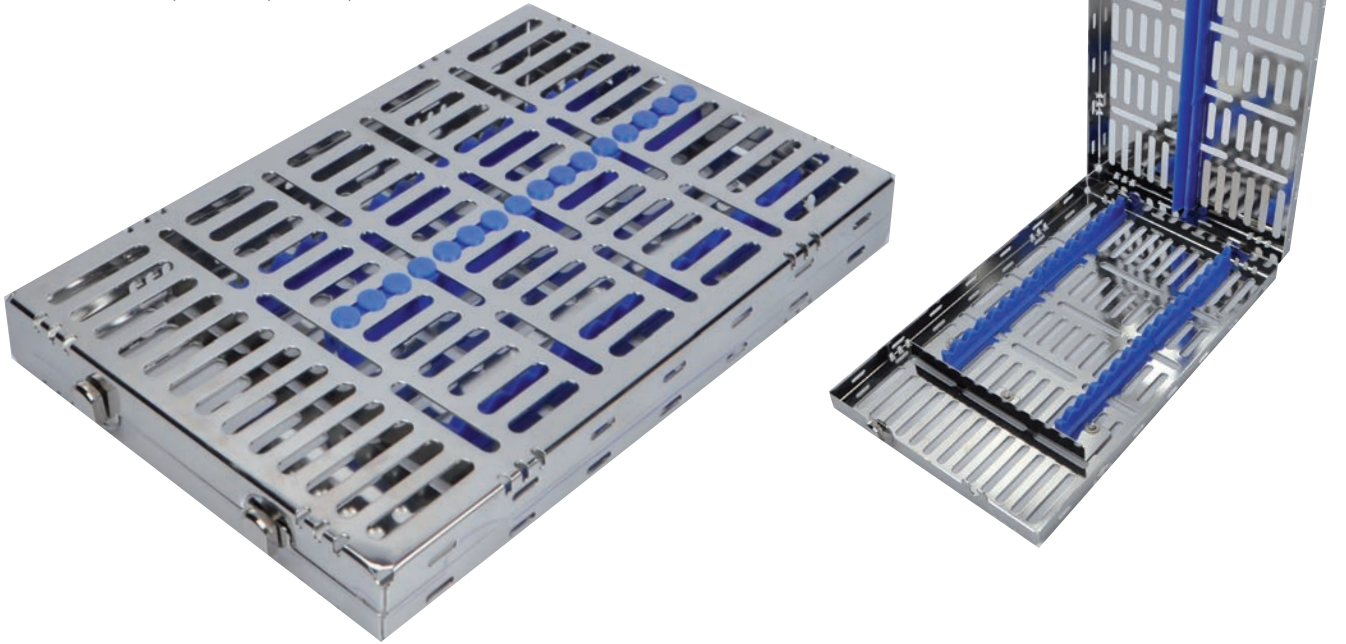

Edelstahltray (20 Instrumente)

Ref. 15-54 280,0 x 205,0 x 32,0 mm

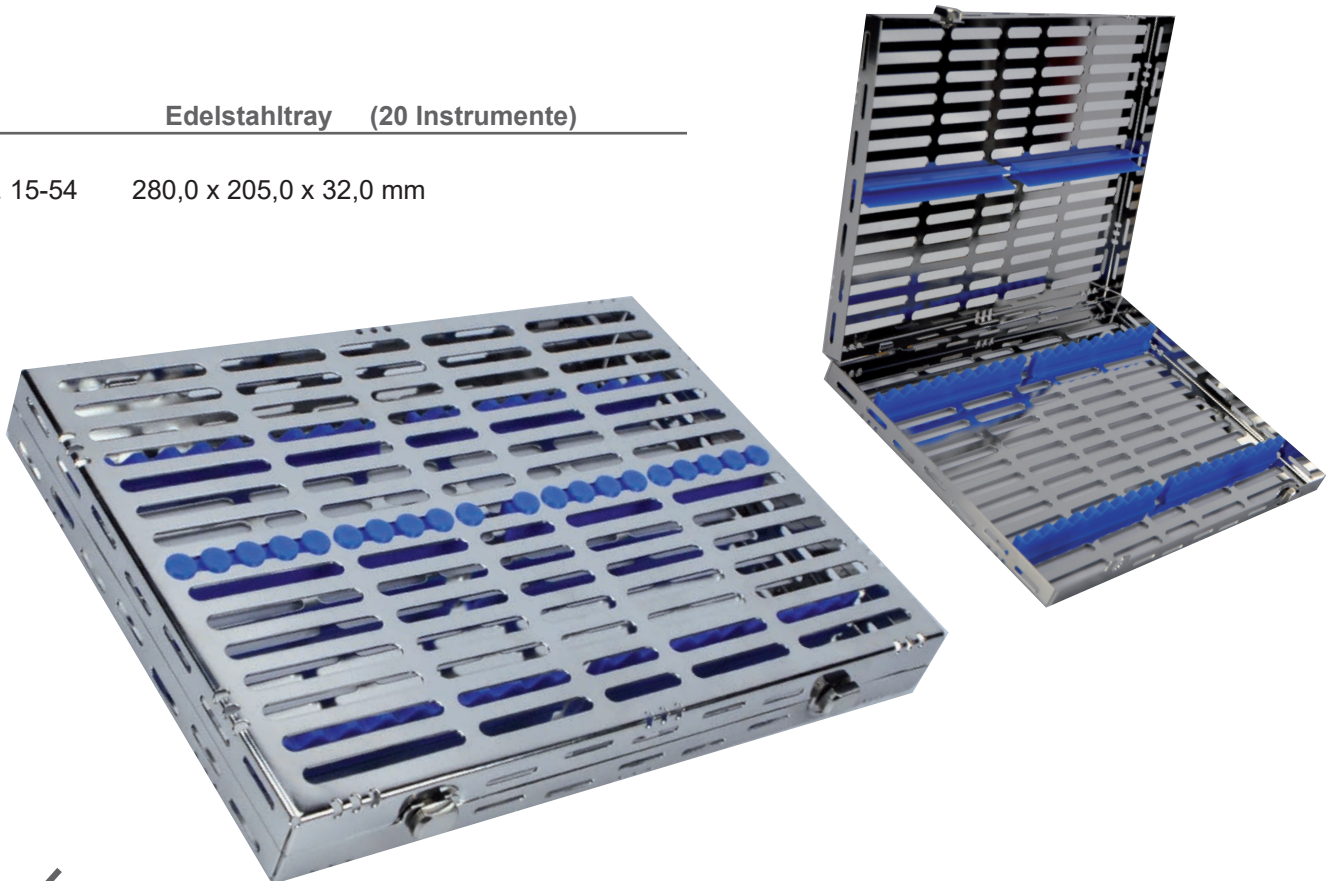

Ref. 15-80



180,0 x 148,0 x 50,0 mm

Ref. 15-81



150,0 x 85,0 x 50,0 mm

Ref. 15-82

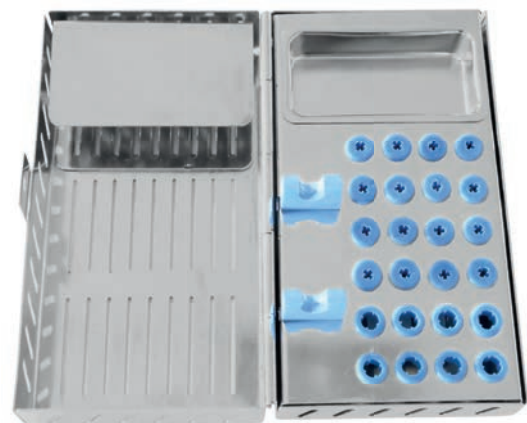

150,0 x 85,0 x 50,0 mm

Bestell-Nr.
Order-No.

Ref. 15-83

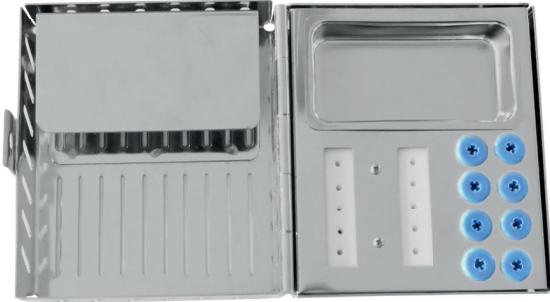

100,0 x 90,0 x 50,0 mm

Ref. 15-84



100,0 x 90,0 x 50,0 mm

Ref. 15-85



80,0 x 55,0 x 40,0 mm

Ref. 15-86

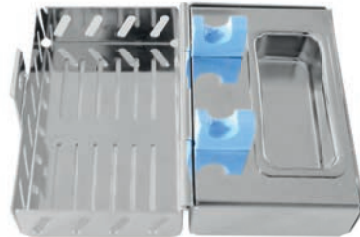

80,0 x 55,0 x 40,0 mm

Bohrerstände

Ref. 15-88



63,0 x 25,0 x 30,0 mm

Ref. 15-87

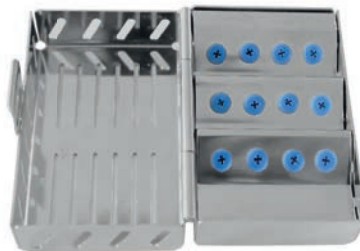

80,0 x 55,0 x 40,0 mm

Endo-Box

Endo-Box

Endo-Box

Ref. 15-90

12
Instrumente



35,0 x 39,0 x 50,0 mm

Ref. 15-91

32
Instrumente



65,0 x 43,0 x 50,0 mm

Ref. 15-92

32
Instrumente



65,0 x 43,0 x 82,0 mm

Waschkörbe Mesh Baskets

Bestell-Nr.
Order-No.

aus feinmaschigem, stabilen Drahtgeflecht!
Vielseitig geeignet für diverse Kleinteile
zur Reinigungsunterstützung im
Ultraschallbad und Waschautomaten.

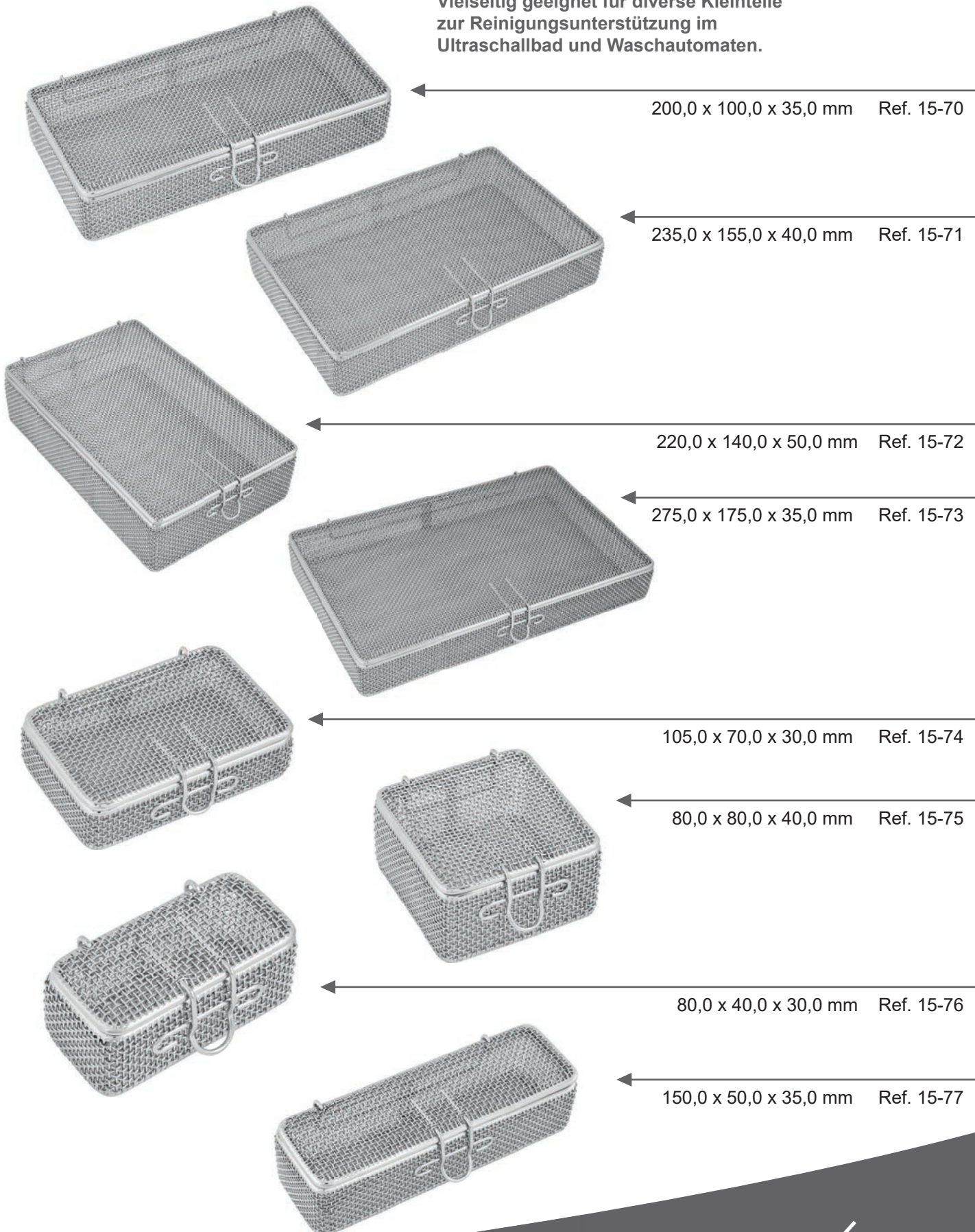

Bestell-Nr.
Order-No.

Wattespender Cotton-Wool-Dispenser

Ref. 15-19



Abfallbehälter Waste receiver

Ref. 15-19A



Spirituslampe Alcohol-Lamp

Ref. 15-20



Nierenschale Kidney-dishes

Ref. 15-21

25,0 x 15,0 cm



Instrumentenschale Instrument-tray

19,0 x 10,0 cm Ref. 15-22



Tray-Schale

20,0 x 10,0 cm Ref. 15-22A



Tray-Schale

20,5 x 11,5 cm Ref. 15-22B



Bestell-Nr.
Order-No.

Separator nach Ivory

Ref. 15-25



Wangenabhalter nach Hilger

Ref. 15-30



Passend für alle Spiegelgriffe
auf Seite 126.

Wundspreizer

Ref. 15-28



7,0 cm

Wundspreizer

Ref. 15-29

Backen gezahnt

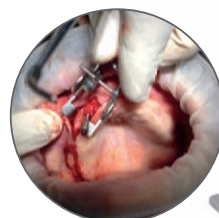

4,5 cm



Schlaufensystem

Ref. 16-10

zur schonenden Kronen- und
Brückentfernung



Ersatzseil
9,0 cm

Ref. 16-11



Doppel-Schlaufensystem

Ref. 16-12



Ersatzseil
20,0 cm

Ref. 16-13



Ultraschallgerät 3 Liter mit Heizung aus Edelstahl

Ref. 50-01

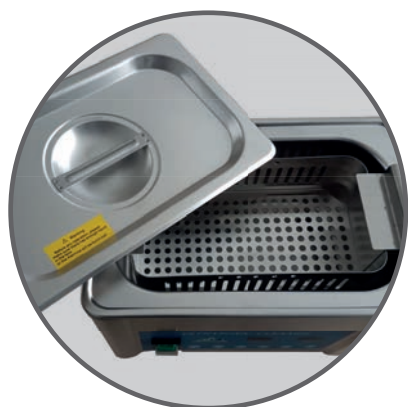

mit Siebkorb
aus Edelstahl



Ablasshahn

Bestell-Nr.
Order-No.

nach Morell

Ref. 16-4



nach Morell

Ref. 16-4A

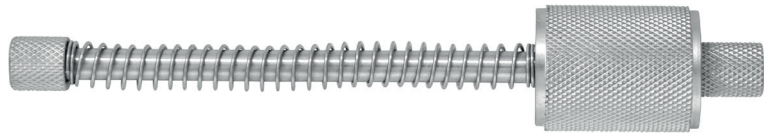

nach Morell

Ref. 16-5



Doppelending



Crown-Click

Ref. 16-7

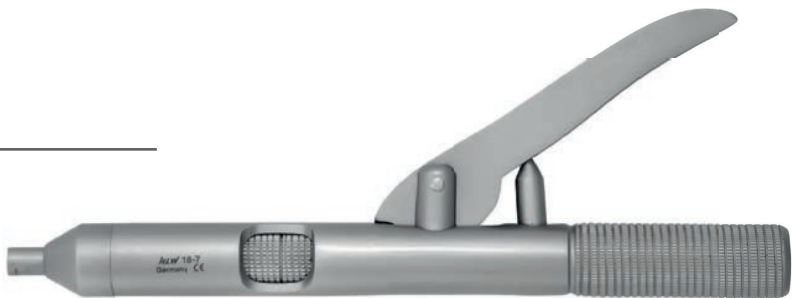

Injektionsspritzen

Syringes



Bestell-Nr.
Order-No.

Ref. 17-1

straight

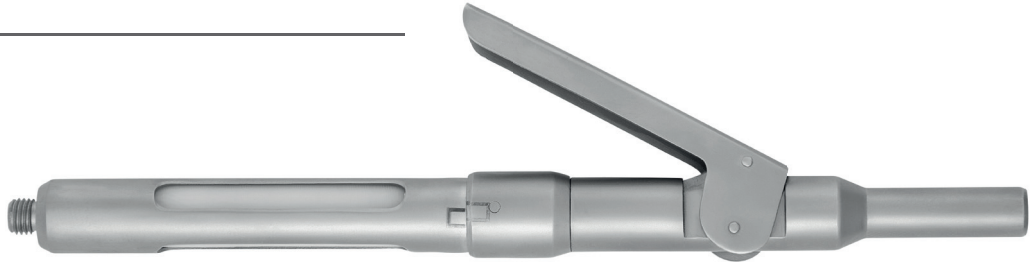

Zur Intraligamentären Anästhesie

curved



Mit Ersatzampullenhalter
with reserve holder

Ref. 17-2

Zur Intraligamentären Anästhesie



Selbstaspirierende Injektionsspritze
Self-Aspirating-Syringe

Ref. 17-7



Thermoplast - sterilisierbar bis 200° C

Zylinder-Ampullen-Spritze Aspirating Syringe

Ref. 17-3

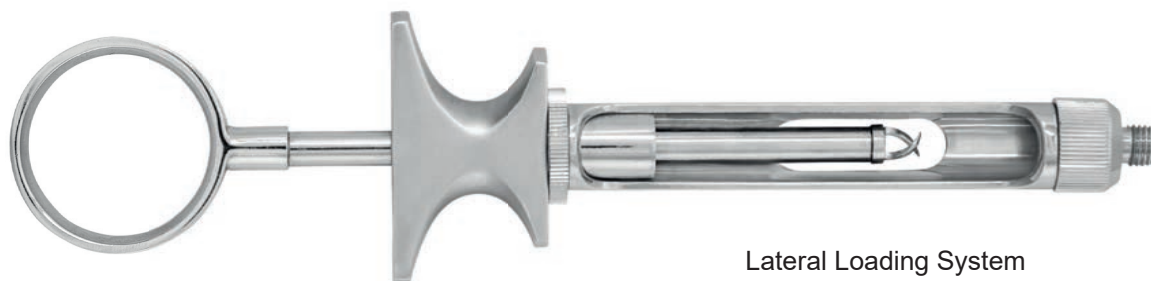

Lateral Loading System

Aspirationsspritze mit 3 Hackchen Aspirating Syringe with moveable hooks

Ref. 17-4

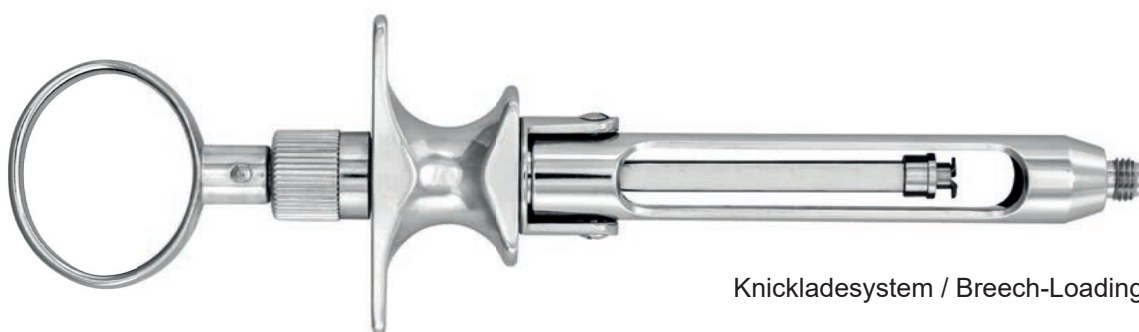

Knickladesystem / Breech-Loading-System

Aspirationsspritze mit 3 Hackchen Aspirating Syringe with moveable hooks

Ref. 17-4A

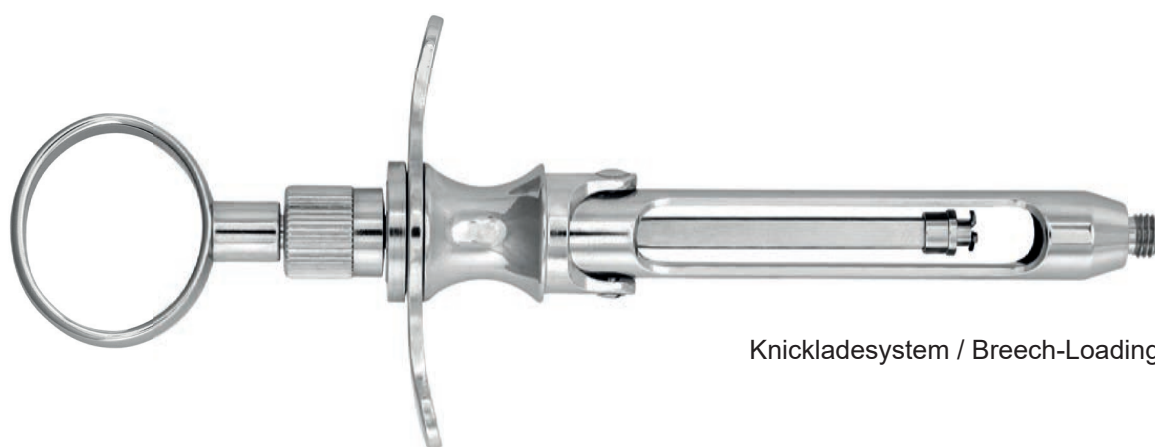

Knickladesystem / Breech-Loading-System

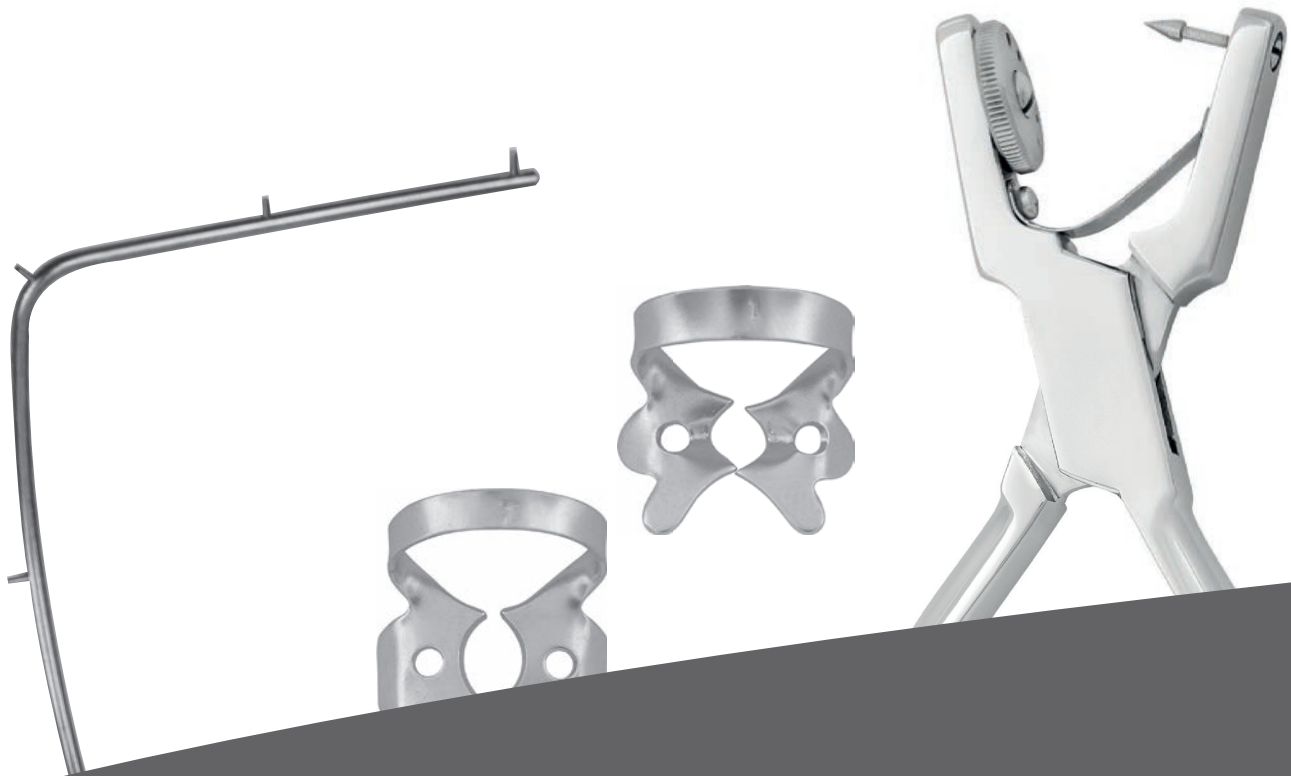

Kofferdam-Klammer & Lochzangen
Rubber Dam Clamp & Punch Forceps

Kofferdam-Klammern
Rubber Dam Clamp

Kofferdam-Klammer & Lochzangen

Rubber Dam Clamp & Punch Forceps

Bestell-Nr.
Order-No.

nach Stockes



Ref. 18-1

nach Brewer

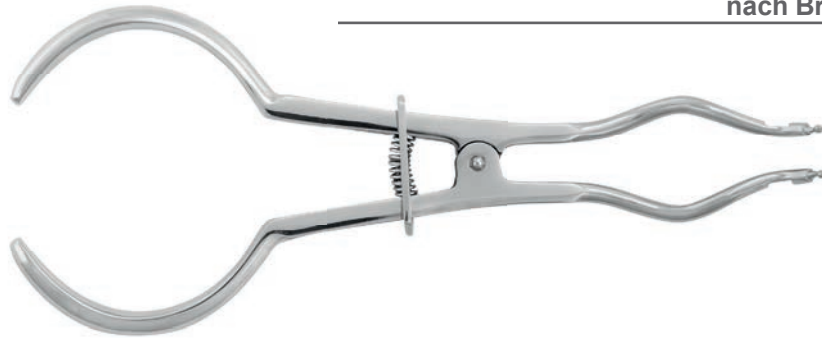

Ref. 18-2

nach Ivory



Ref. 18-3

nach Ainsworth



Ref. 18-4

nach Ivory



Ref. 18-5

Bestell-Nr.
Order-No.

Anterior



#9



Ref. 18-10



#212



Ref. 18-11



#6



Ref. 18-12

Prämolaren



#0



Ref. 18-13



#1



Ref. 18-14



#2



Ref. 18-15



#2A



Ref. 18-16

Molaren



#7



Ref. 18-17



#8



Ref. 18-18



#8A



Ref. 18-19



#14



Ref. 18-20



#14A



Ref. 18-21

Kofferdam Rubber Dam

Bestell-Nr.
Order-No.

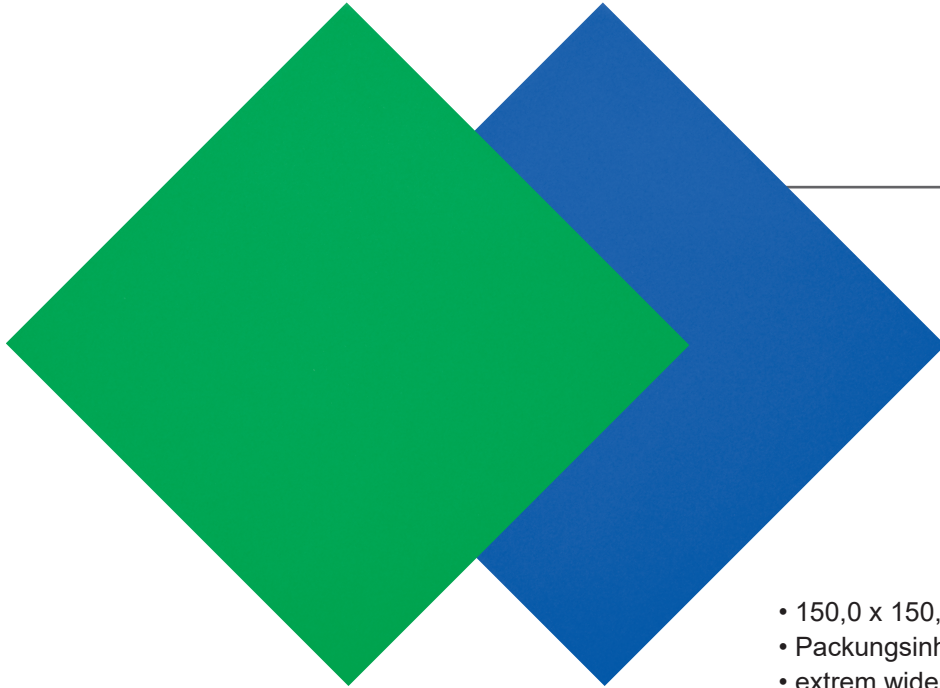

Kofferdam

grün

dünn	Ref. 18-41D
mittel	Ref. 18-41M
schwer	Ref. 18-41S
x-schwer	Ref. 18-41X

blau

mittel	Ref. 18-42M
schwer	Ref. 18-42S
x-schwer	Ref. 18-42X

- 150,0 x 150,0 mm
- Packungsinhalt 36 Stück
- extrem widerstandsfähig
- hautfreundlich
- vakuumverpackt

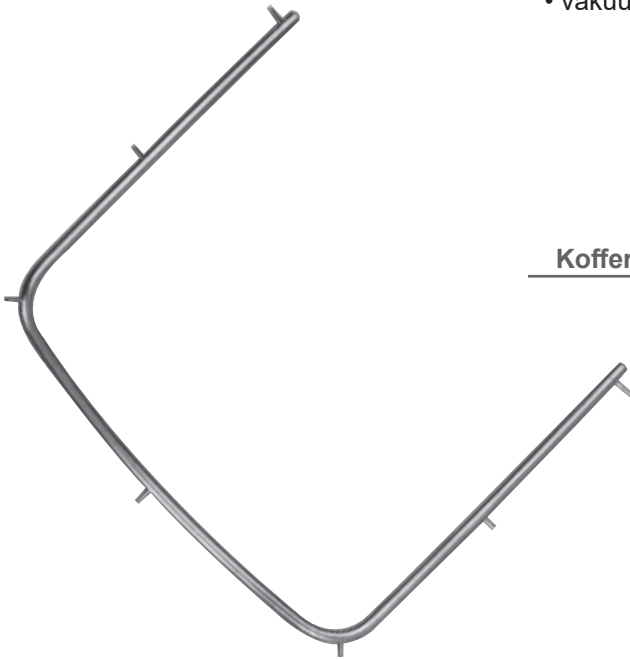

Kofferdamrahmen Rubber-Dam Arch

Ref. 18-50

Klammerboard 12er-Set

Ref. 18-31



Scheren Scissors

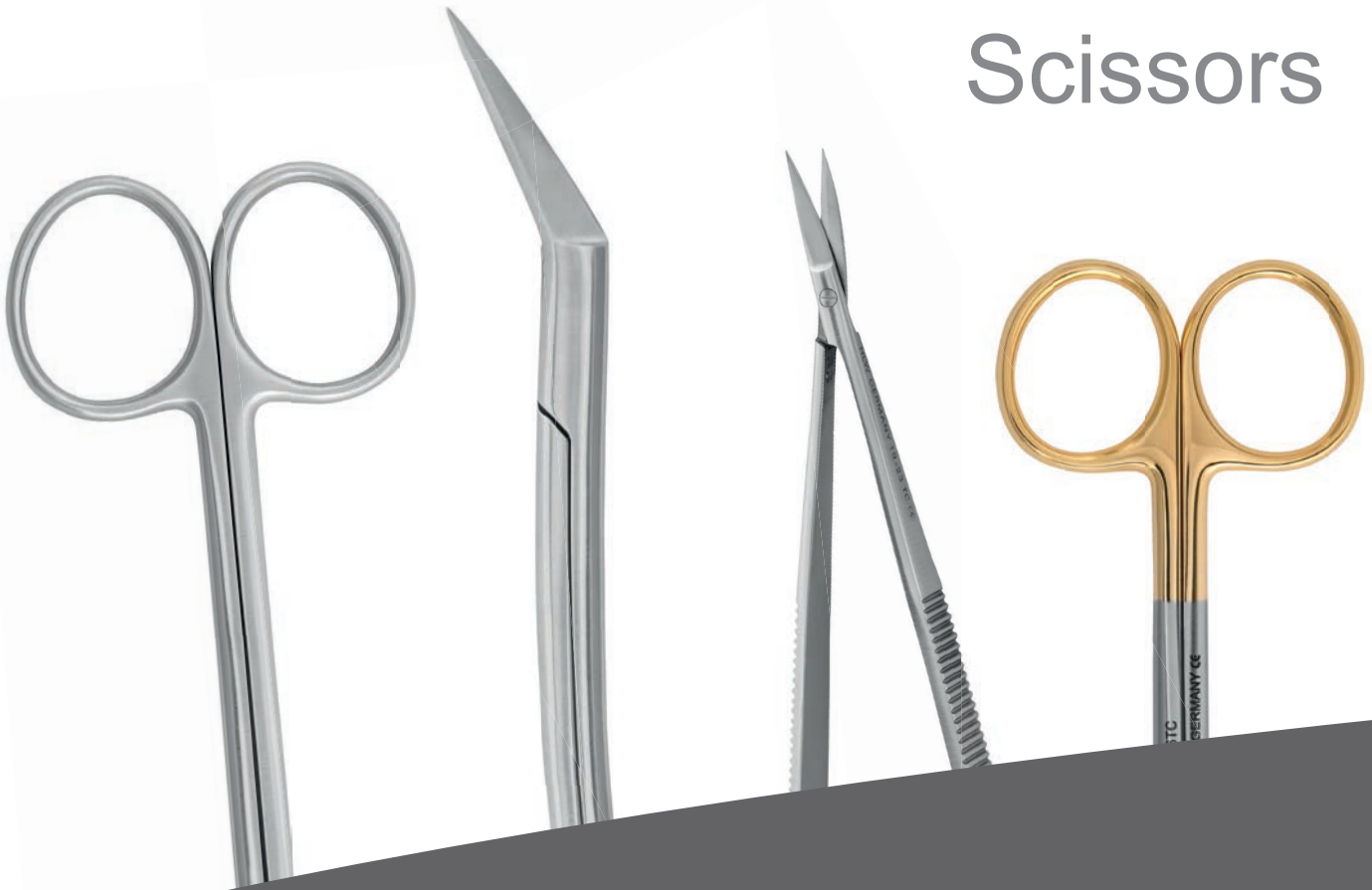

Mikroscheren
Micro Scissors

Scheren mit Hartmetalleinsatz (TC)
Scissors with tungsten-carbide (TC)



Ref. 19-50



Ref. 19-51



Ref. 19-52

Bestell-Nr.
Order-No.

Iris

Ref. 19-1

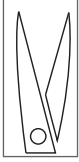

gerade
straight



11,5 cm gezahnt/serrated

Iris

Ref. 19-2

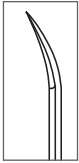

gebogen
curved



11,5 cm gezahnt/serrated

Stevens

Ref. 19-3

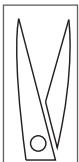

gerade
straight



11,5 cm gezahnt/serrated



11,5 cm gezahnt/serrated

Stevens

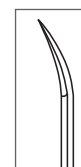

gebogen
curved

Ref. 19-4



12,5 cm gezahnt/serrated

Goldmann-Fox



gerade
straight

Ref. 19-5



12,5 cm gezahnt/serrated

Goldmann-Fox

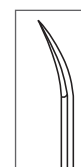

gebogen
curved

Ref. 19-6

Bestell-Nr.
Order-No.

La Grange

Ref. 19-7



double
curved



11,5 cm gezahnt/serrated

La Grange

Ref. 19-8



double
curved

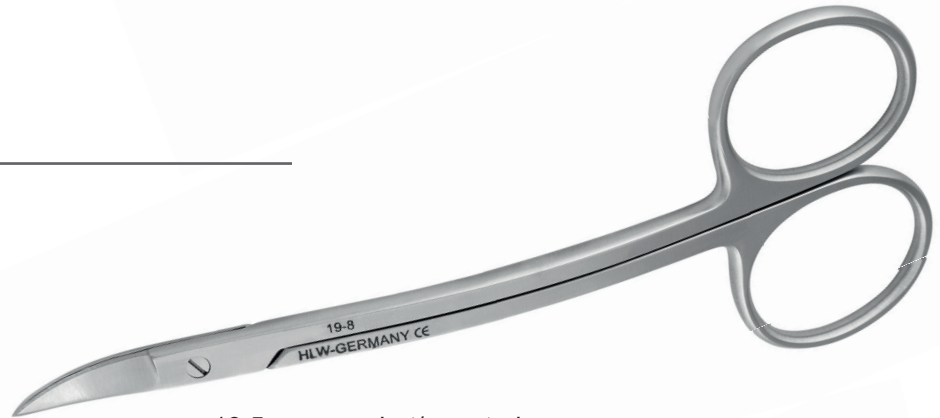

13,5 cm gezahnt/serrated

DEAN

Ref. 19-9



double
curved



17,5 cm gezahnt/serrated

Nahtschere

Ref. 19-13A

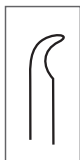

gewinkelt
angled



11,5 cm

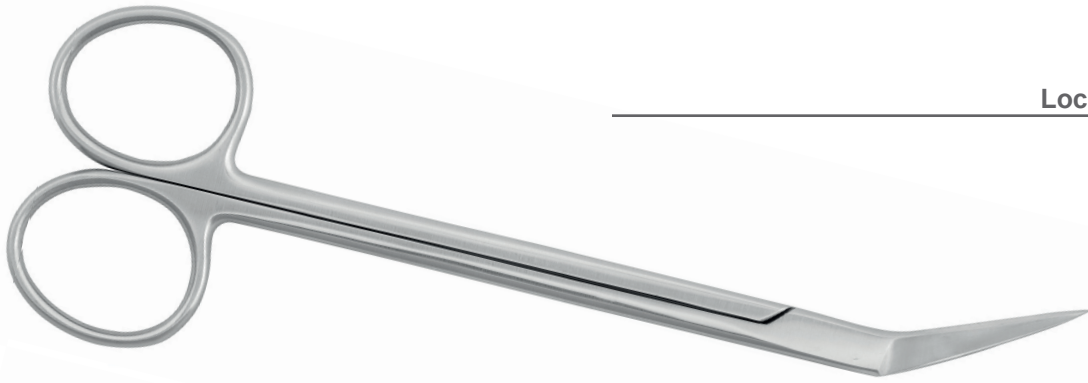

16,0 cm gezahnt/serrated

Locklin

Ref. 19-10

doppelt
gewinkelt
double
angled

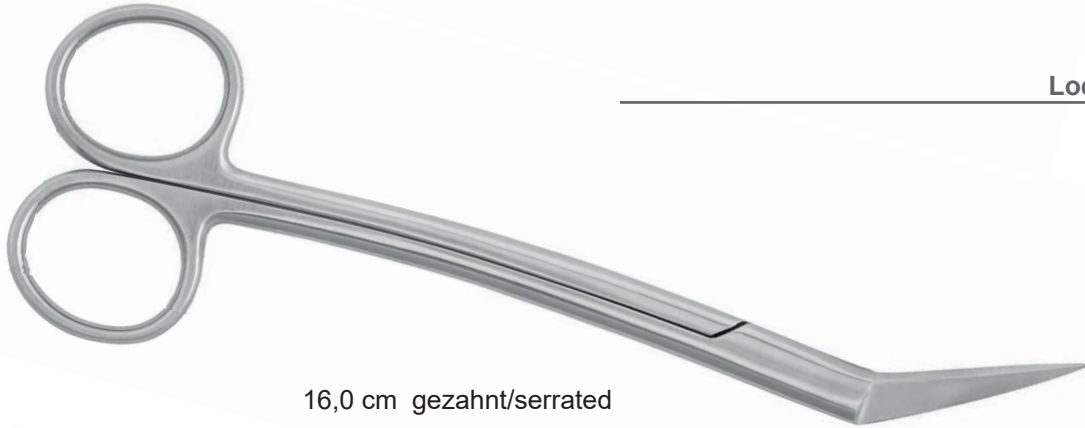

16,0 cm gezahnt/serrated

Locklin

Ref. 19-11

gewinkelt
angled



14,0 cm

Joseph

Ref. 19-12

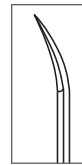

gebogen
curved



16,0 cm gezahnt/serrated

Kelly

Ref. 19-14



gerade
straight

Bestell-Nr.
Order-No.

Kelly

Ref. 19-15

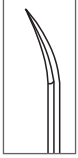

gebogen
curved



16,0 cm gezahnt/serrated

Chirurgische Schere surgical scissor

Ref. 19-16

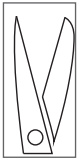

spitz/stumpf
sharp/blunt



14,5 cm

Chirurgische Schere surgical scissor

Ref. 19-17

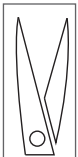

spitz/spitz
sharp/sharp



14,5 cm

Verbandschere bandage scissor

Ref. 19-27



14,5 cm



10,0 cm

Kronenschere



gerade
straight

gezahnt/serrated
Ref. 19-18

glatt/smooth
Ref. 19-19



10,0 cm

Kronenschere

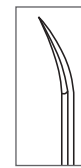

gebogen
curved

gezahnt/serrated
Ref. 19-20

glatt/smooth
Ref. 19-21



Drahtschere Wire - Scissor

gewinkelt
angled

Ref. 19-22



11,0 cm

Kronenschere

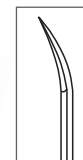

gebogen
curved



spitz/spitz
sharp/sharp

Ref. 19-20A

Bestell-Nr.
Order-No.

Metzenbaum

Ref. 19-25

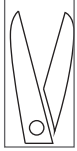

stumpf/blunt
gerade/straight



12,0 cm

Metzenbaum

Ref. 19-26

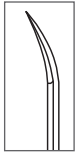

stumpf/blunt
gebogen/curved



14,5 cm

Fadenschere

Ref. 19-24

gewinkelt
angled



11,5 cm

Zahnfleischscherer

Ref. 19-2A

seitwärts gebogen
side curved



11,5 cm

Scheren Super-Cut
Scissors Super-Cut

Bestell-Nr.
Order-No.



11,5 cm

SUPER-CUT

Iris

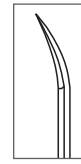

Ref. 19-1SC
Ref. 19-2SC

gebogen
curved



12,0 cm

SUPER-CUT

La Grange



Ref. 19-7SC

double
courved



13,0 cm

SUPER-CUT

Goldmann-Fox

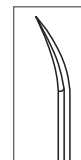

Ref. 19-6SC

gebogen
curved



16,0 cm

SUPER-CUT

Kelly

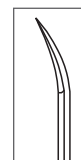

Ref. 19-15SC

gebogen
curved

Die HLW SUPER-CUT Scheren zeichnen sich an einer Seite der Schneide, durch einen Spezialschliff und an der gegenüberliegenden Schneide, durch eine Micro-Zahnung aus.

The HLW SUPER-CUT Scissors has two different cutting blades – one with razor sharp edge and the other with micro-serrations.



Bestell-Nr.
Order-No.

Castroviejo-Gomel TC

Ref. 19-28TC

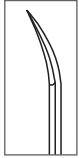

gebogen
curved

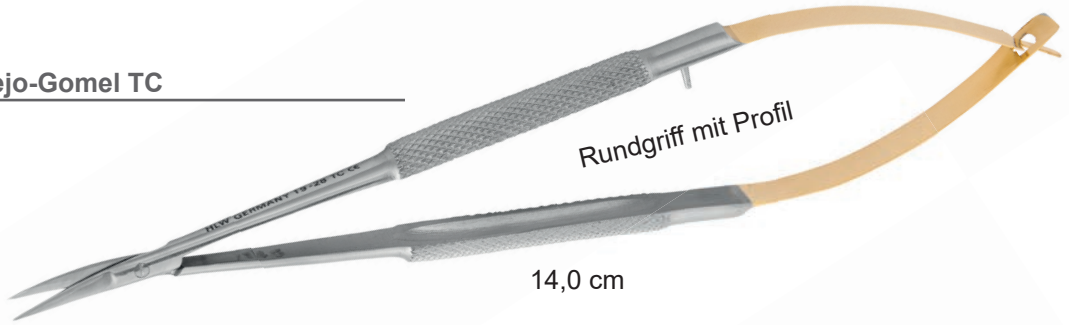

14,0 cm

Castroviejo TC

Ref. 19-23TC

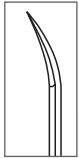

gebogen
curved

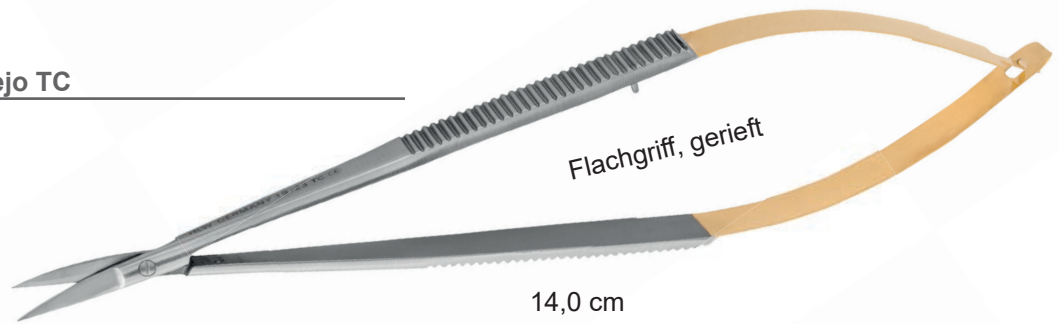

14,0 cm

Castroviejo-Gomel

Ref. 19-28

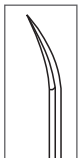

gebogen
curved

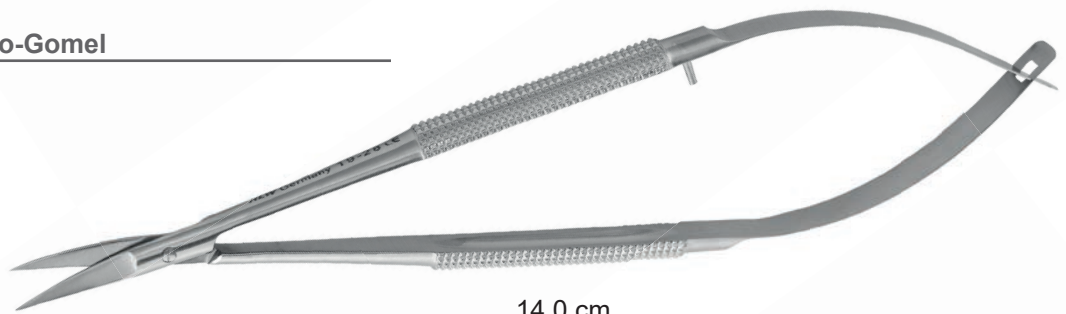

14,0 cm

Castroviejo

Ref. 19-23

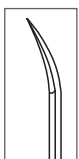

gebogen
curved

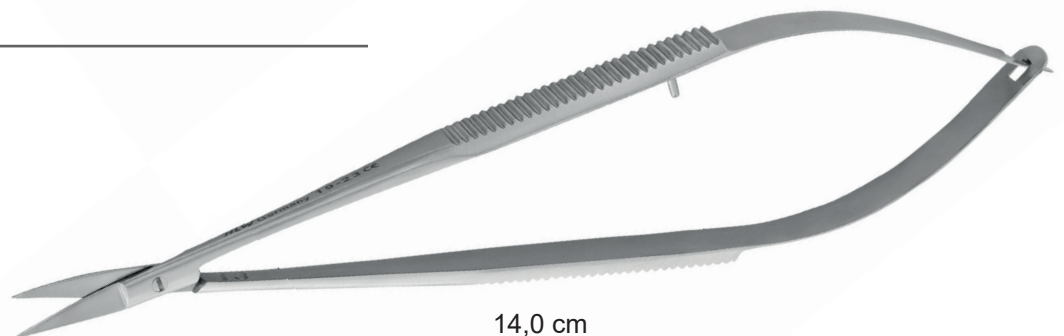

14,0 cm

Scheren mit Hartmetalleinsatz (TC)
Scissors with tungsten-carbide (TC)

Bestell-Nr.
Order-No.



Iris - Schere TC

gezahnt
serrated

(gerade/straight) Ref. 19-1TC
(gebogen/curved) Ref. 19-2TC

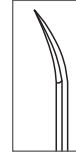

gebogen
curved



La Grange Schere TC

gezahnt
serrated

Ref. 19-7TC



doppelt gebogen
double curved



Goldmann-Fox TC

gezahnt
serrated

Ref. 19-6TC



gebogen
curved



Bestell-Nr.
Order-No.

Kelly TC

Ref. 19-15TC

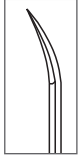

gebogen
curved

gezahnt
serrated



16,0 cm

Micro Schere TC

Ref. 19-23B

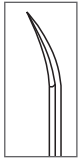

gebogen
curved

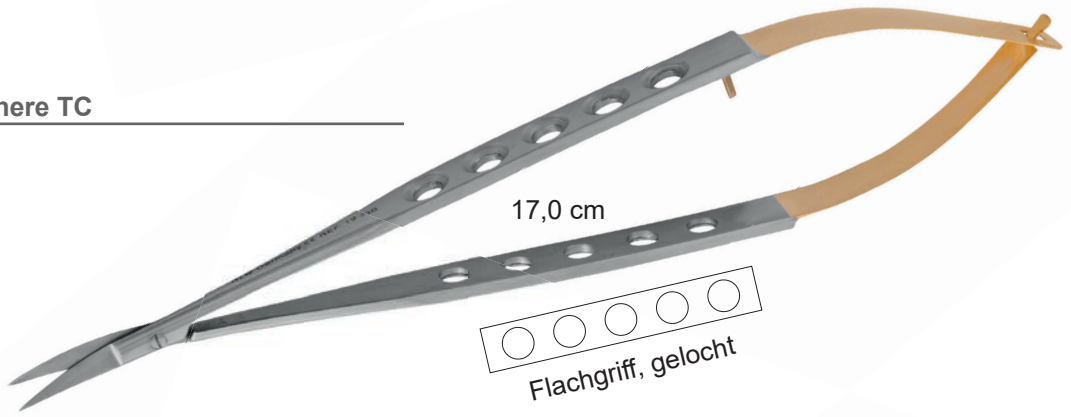

17,0 cm



Flachgriff, gelocht

Micro Schere TC

Ref. 40-48B

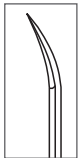

gebogen
curved

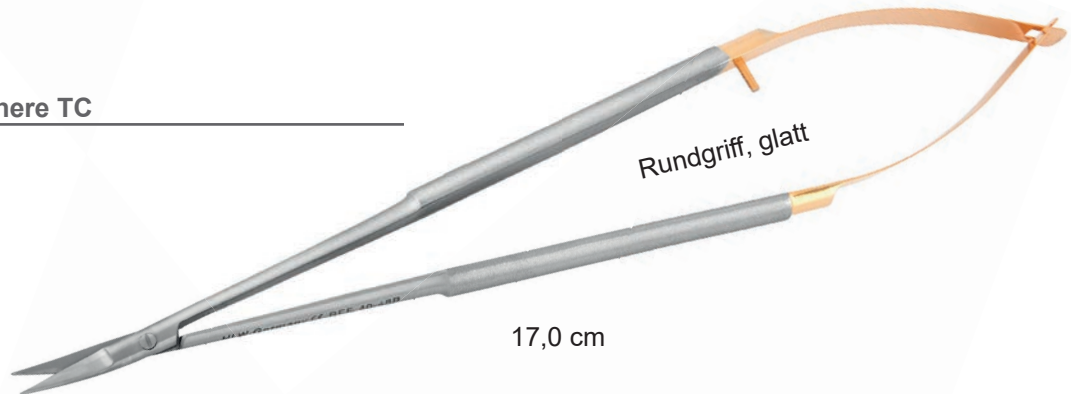

17,0 cm

Rundgriff, glatt

Metzenbaum

Ref. 19-26TC

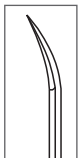

gebogen
curved

feine Spitze

TC-Hartmetall



14,5 cm



Iris Schere

Ref. 19-1SCS

SUPER-CUT

11,5 cm

gerade
straight

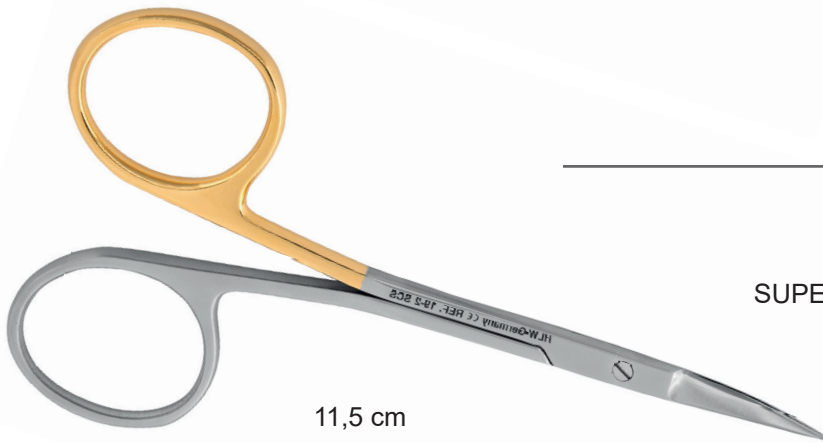

Iris Schere

Ref. 19-2SCS

SUPER-CUT

11,5 cm

gebogen
curved

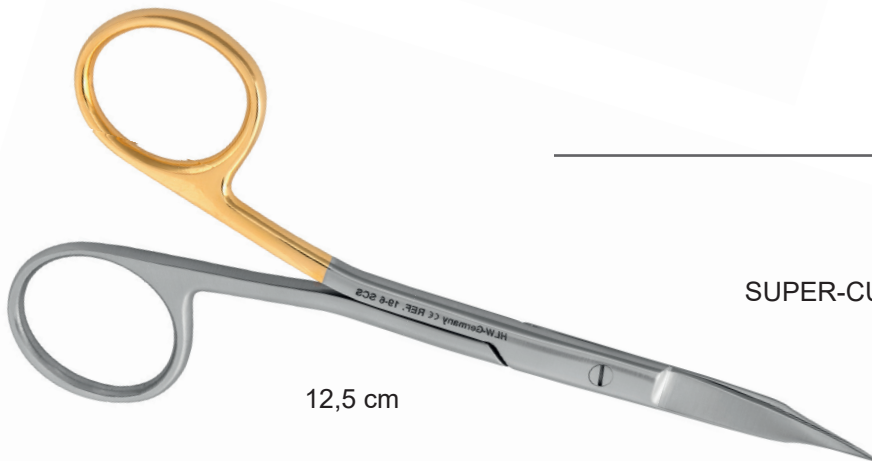
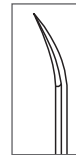

Goldmann-Fox

Ref. 19-6SCS

SUPER-CUT

12,5 cm

doppelt gebogen
double curved



Klemmen Forceps

Nadelhalter Needle Holder



Arterienklemmen
Hemostatic Forceps

Tuchklemmen
Towel Forceps

Nadelhalter
Needle Holder

Nadelhalter TC
Needle Holder TC



12,5 cm

Halstead-Mosquito

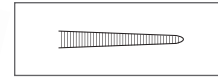

gerade/straight

Ref. 20-1



12,5 cm

Halstead-Mosquito

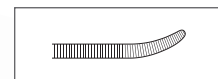

gebogen/curved

Ref. 20-2

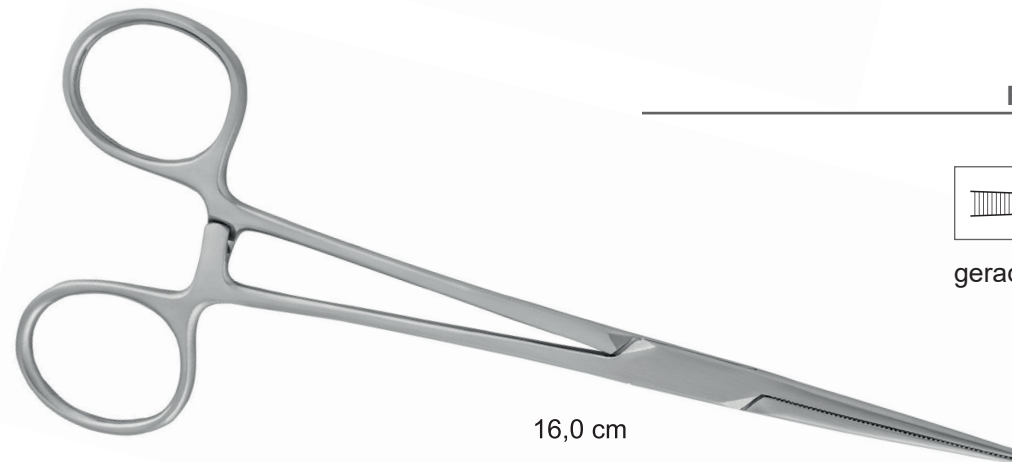

16,0 cm

Rankin-Crile

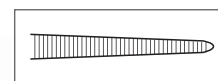

gerade/straight

Ref. 20-3

Bestell-Nr.
Order-No.

Rankin-Crile

Ref. 20-4

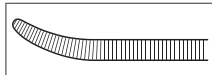

gebogen/curved

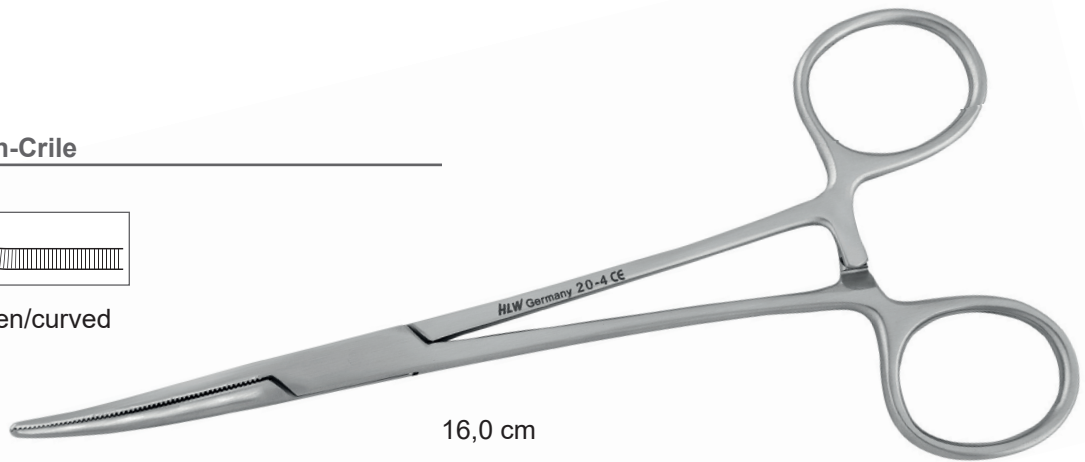

Kocherklemme

Ref. 20-33

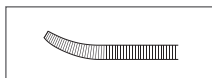

gebogen/curved



Kocherklemme

Ref. 20-34

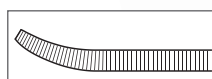

gebogen/curved





Backhaus

Ref. 20-5

9,0 cm



Backhaus

Ref. 20-6

11,0 cm



Tuchklemme mit Kugel

Ref. 20-7

9,5 cm

Bestell-Nr.
Order-No.

Derf

Ref. 20-8



Webster

Ref. 20-8A

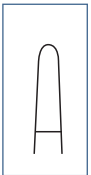

glatt
smooth

Abbey

Ref. 20-9

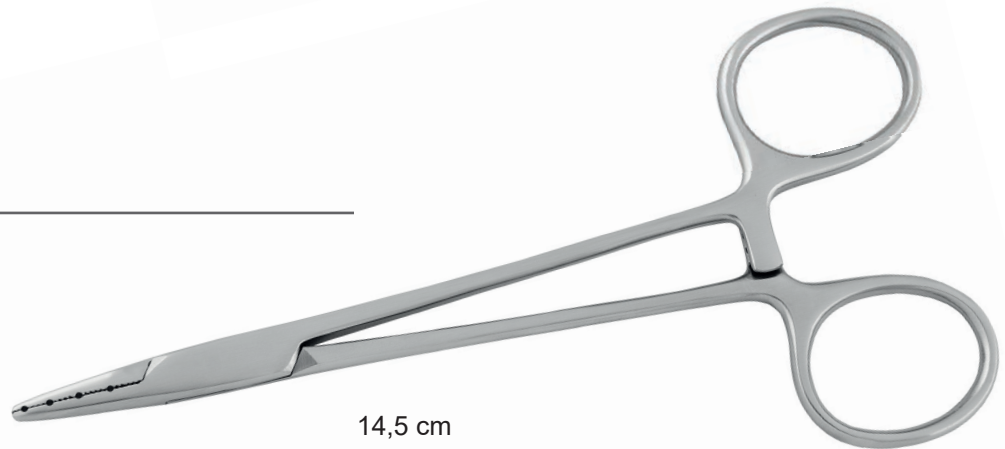
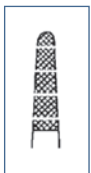



14,5 cm

Baumgartner



Ref. 20-10



15,0 cm

Crile-Wood



Ref. 20-15



16,0 cm

Mayo-Hegar

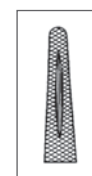

Ref. 20-12

Bestell-Nr.
Order-No.

Mathieu

Ref. 20-13



14,0 cm

Mathieu

Ref. 20-14



17,0 cm

Mathieu

Ref. 20-14A



Mini-Head



17,0 cm

Micro-Nadelhalter Castroviejo

Ref. 20-16

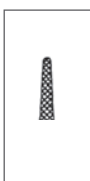

14,0 cm

Castroviejo - Gomel TC



14,0 cm

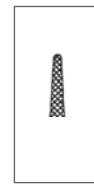

gerade
straight

Ref. 20-19

Castroviejo - Gomel TC

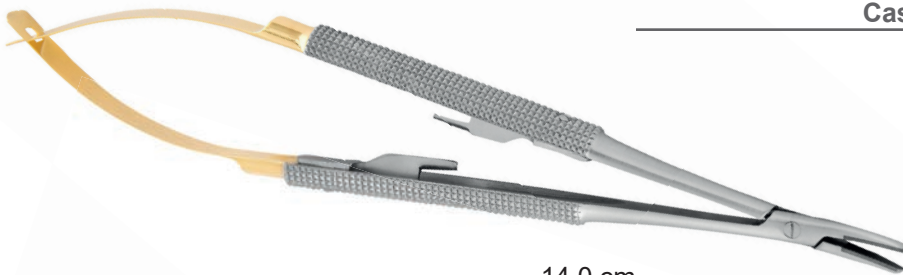

14,0 cm

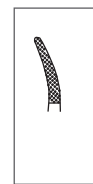

gebogen
curved

Ref. 20-17

Castroviejo - Gomel TC

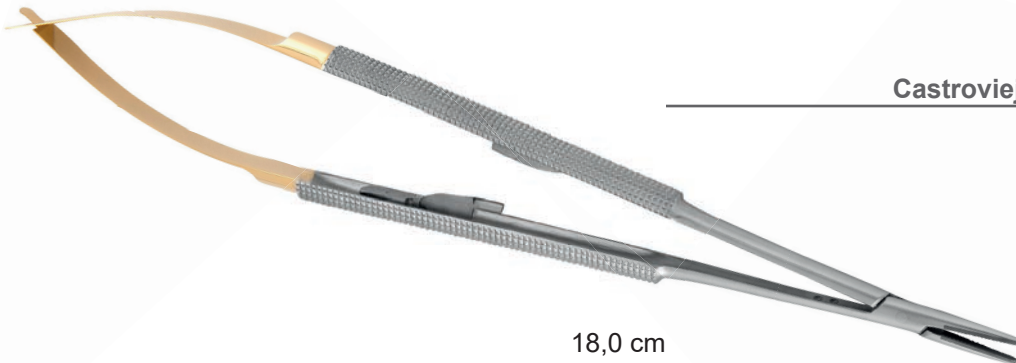

18,0 cm



gerade
straight

Ref. 20-20

Castroviejo - Gomel TC

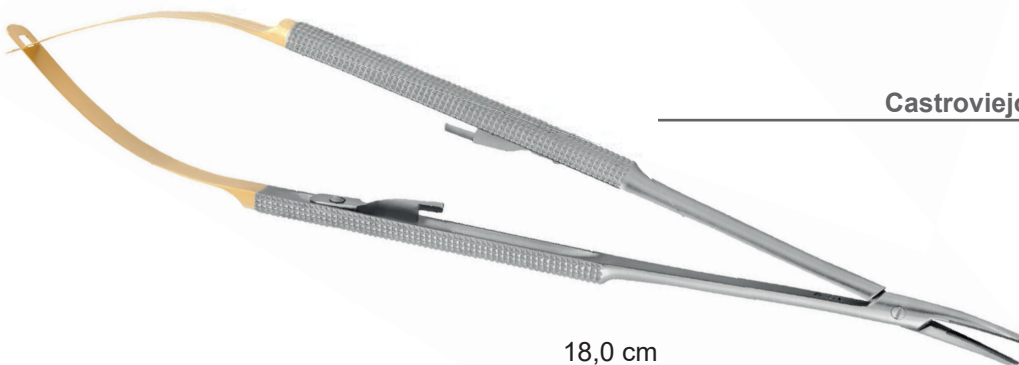

18,0 cm

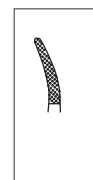

gebogen
curved

Ref. 20-18

Bestell-Nr.
Order-No.

Micro-Nadelhalter Castroviejo TC

Ref. 20-28



gerade
straight



14,0 cm

Micro-Nadelhalter Castroviejo TC

Ref. 20-29

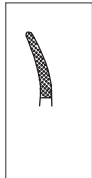

gebogen
curved



14,0 cm

Micro-Nadelhalter TC

Ref. 40-46

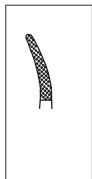

gebogen
curved

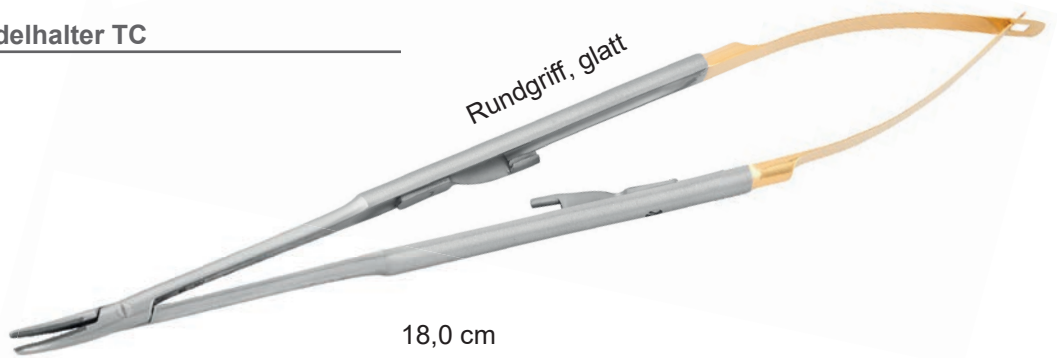

18,0 cm

Micro-Nadelhalter TC

Ref. 40-47

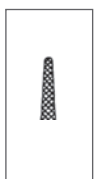

gerade
straight

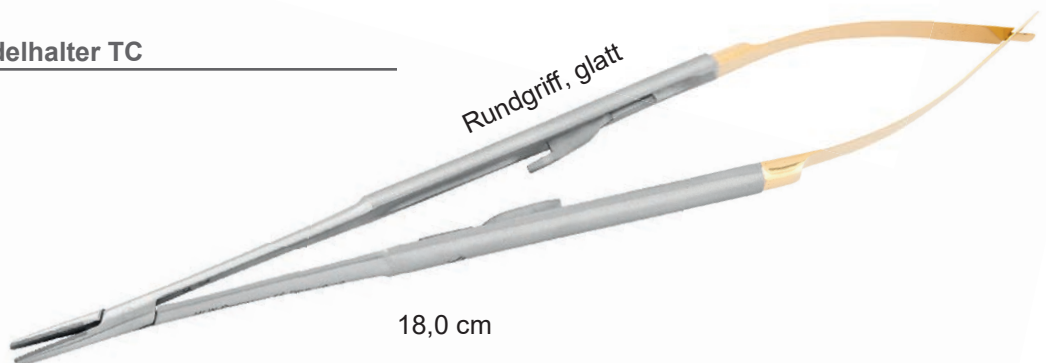

18,0 cm

Nadelhalter TC
Needle Holder TC

Bestell-Nr.
Order-No.



14,0 cm

Lichtenberg TC

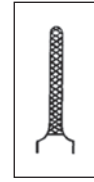

Mini-Rider

Ref. 20-21



14,0 cm

Lichtenberg TC

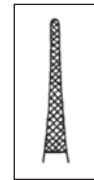

Mini-Head

Ref. 20-21A

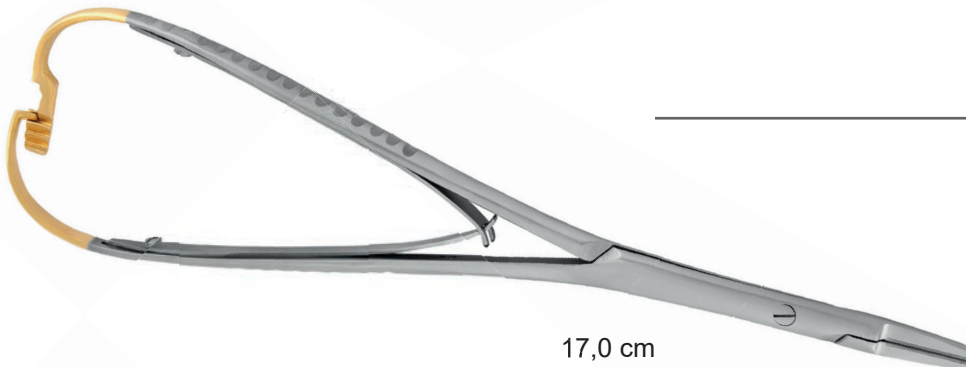

17,0 cm

Lichtenberg TC

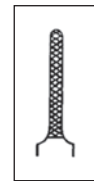

Mini-Rider

Ref. 20-22



17,0 cm

Lichtenberg TC

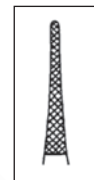

Mini-Head

Ref. 20-22A



Bestell-Nr.
Order-No.

Nadelhalter TC

Ref. 20-22B



gebogen
curved



17,0 cm

Hoesl TC

Ref. 20-31

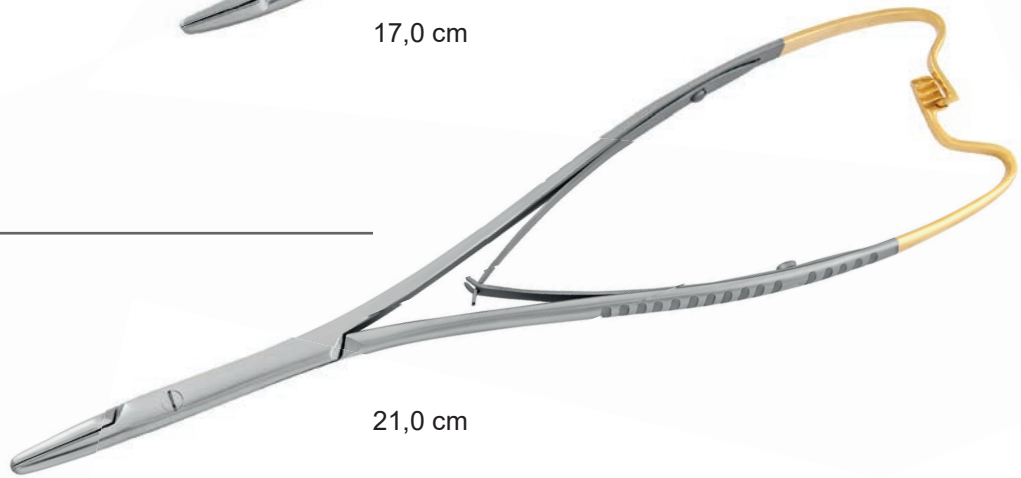
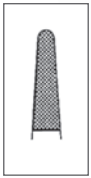

21,0 cm

Toennis TC

Ref. 20-23



gerade
straight



18,0 cm

Castroviejo - Gomel TC

Ref. 20-30



gerade
straight

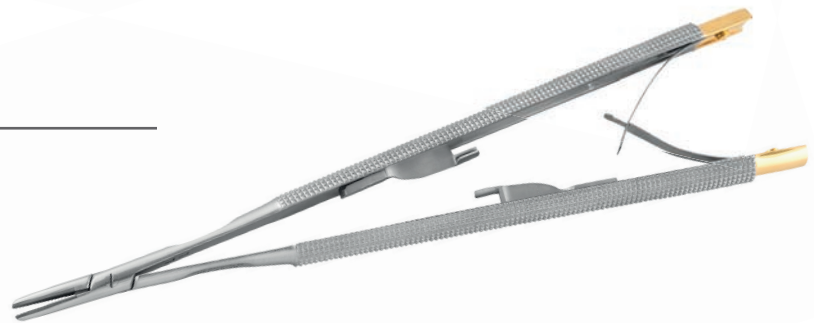

16,0 cm



17,0 cm

Mathieu-Olsen TC

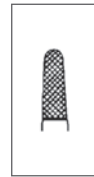

gerade
straight

Ref. 20-32



15,0 cm

Olsen-Hegar TC



gerade
straight

Ref. 20-24



16,0 cm

Mayo-Hegar TC

Ref. 20-25

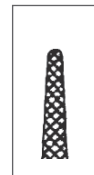

gerade
straight

Ref. 20-25M



gerade
straight

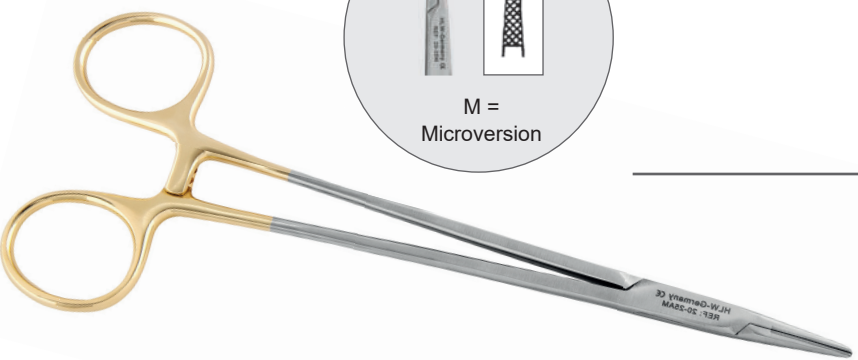
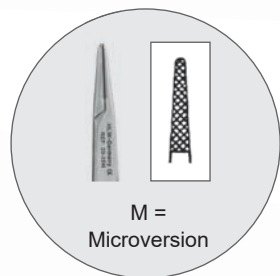

18,0 cm

Mayo-Hegar TC

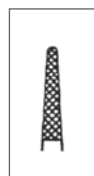

gerade
straight

Ref. 20-25AM

Bestell-Nr.
Order-No.

Mikro-Nadelhalter diamantiert gerade

Ref. 40-95D



gerade
straight

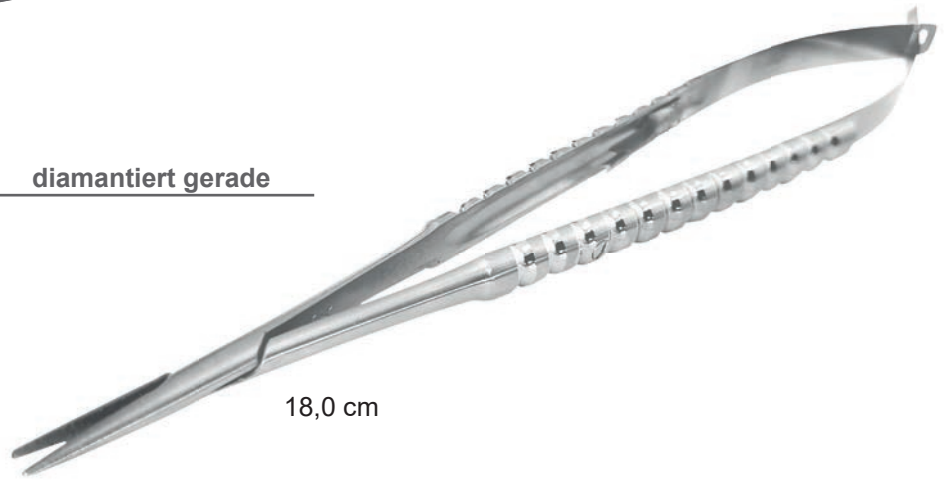

18,0 cm

Mikro-Nadelhalter diamantiert gebogen

Ref. 40-96D

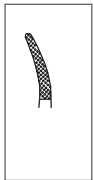

gebogen
curved

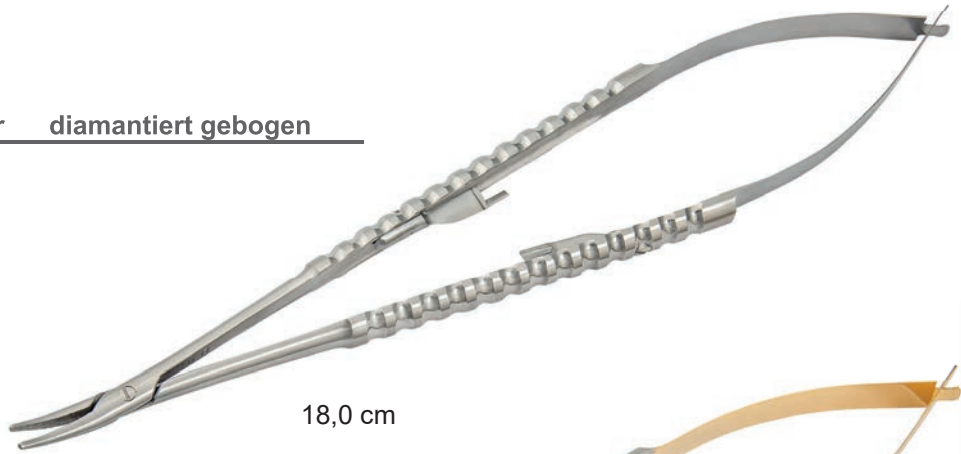

18,0 cm

Mikro-Nadelhalter TC gerade

Ref. 40-95TC

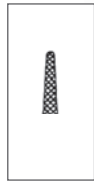

gerade
straight



18,0 cm

Mikro-Nadelhalter TC gebogen

Ref. 40-96TC

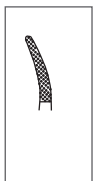

gebogen
curved

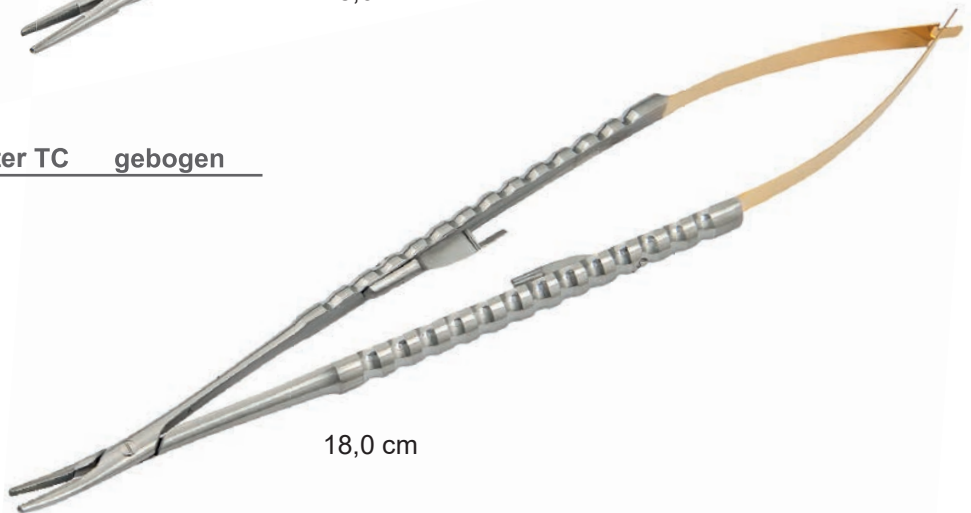

18,0 cm

Mikro-Nadelhalter diamantiert spitz, gerade

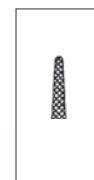

Ref. 40-95DS

gerade
straight



18,0 cm



diamantiert
spitz

Matrizenspanner Matrix Retainer

Matrizen Matrix



Matrizenspanner / Matrizen
Matrix Retainer / Matrix

Bestell-Nr.
Order-No.

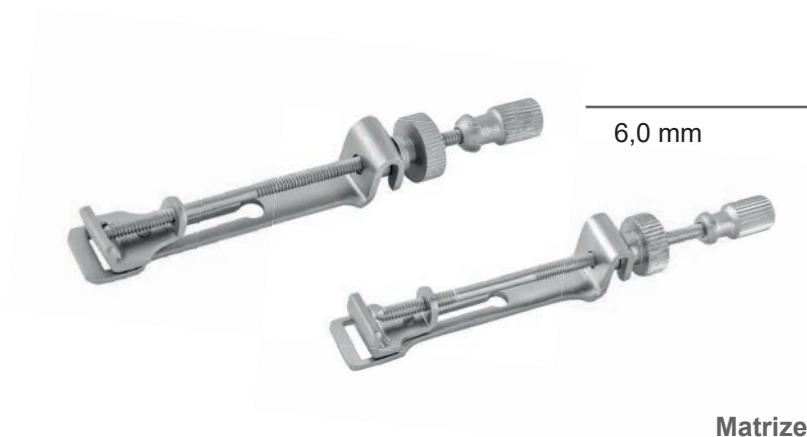

6,0 mm

7,0 mm

Ivory

Ref. 21-17

Ivory

Ref. 21-18

Matrizenbänder

Matrixrolls

Rollenlänge: 1,0 m



6,0 mm

Ref. 21-8

Rollenlänge: 1,0 m



7,0 mm

Ref. 21-9

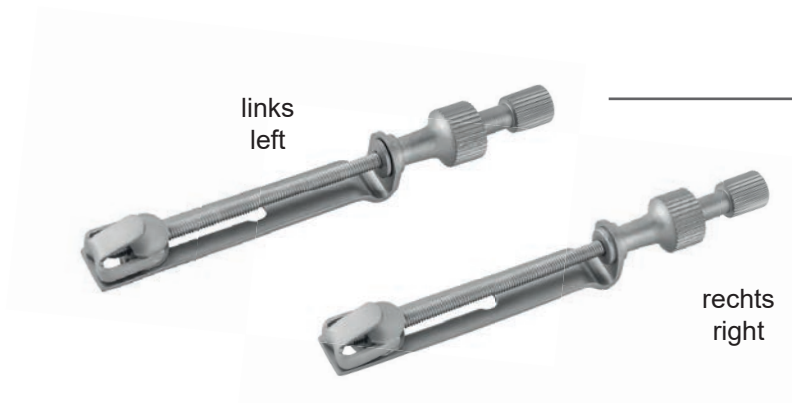

links
left

rechts
right

Nyström

Ref. 21-19

Nyström

Ref. 21-20

(12 pcs of each pack)

Nyström Matrizen

Nyström Matrix



...1



...2



...3

Ref. 21-...



...4



...5



...6

Ref. 21-...



...7

Ref. 21-...



Bestell-Nr.
Order-No.

Ref. 21-21

Tofflemire

Ref. 21-22

Tofflemire



Tofflemire Matrizen **Tofflemire Matrix** (12 pcs of each pack)

Ref. 21-...



...101



...102



...103

Ref. 21-...



...113

Ref. 21-23

Ivory

mit Baken
with shields

Ref. 21-24

Ivory

ohne Baken
without shields



Ivory Matrizen **Ivory Matrix** (12 pcs of each pack)

Ref. 21-...



...11



...12



...13

Ref. 21-...



...14



...15



...16

Pinzetten Tweezers



Bestell-Nr.
Order-No.

Meriam

Ref. 22-1

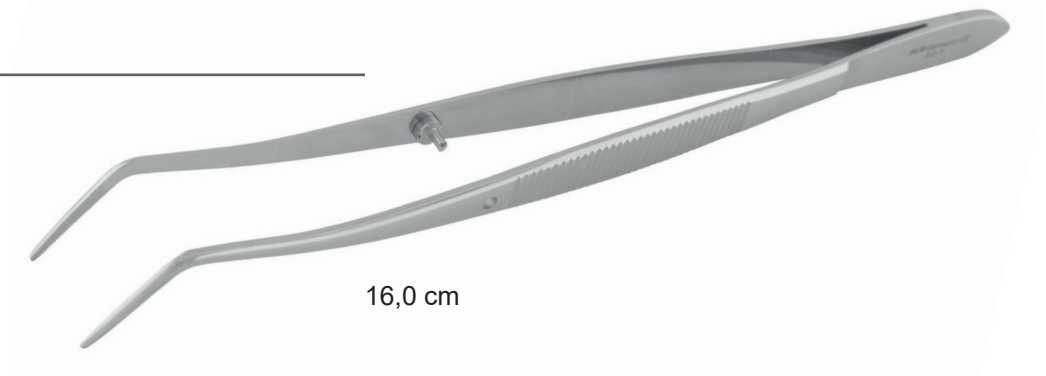

Flagg

Ref. 22-2

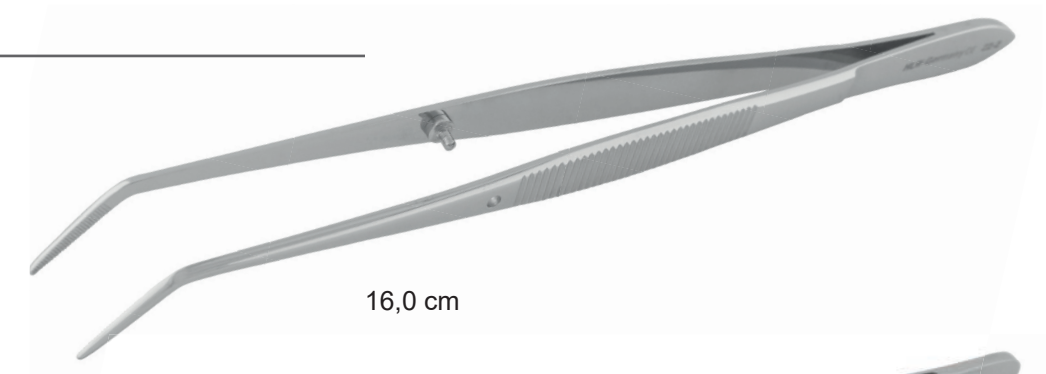

College

Ref. 22-3

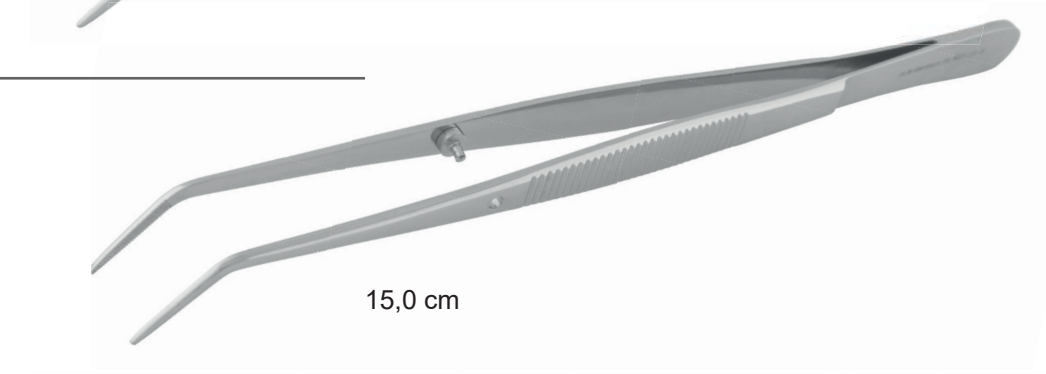

College mit Schloß

Ref. 22-4

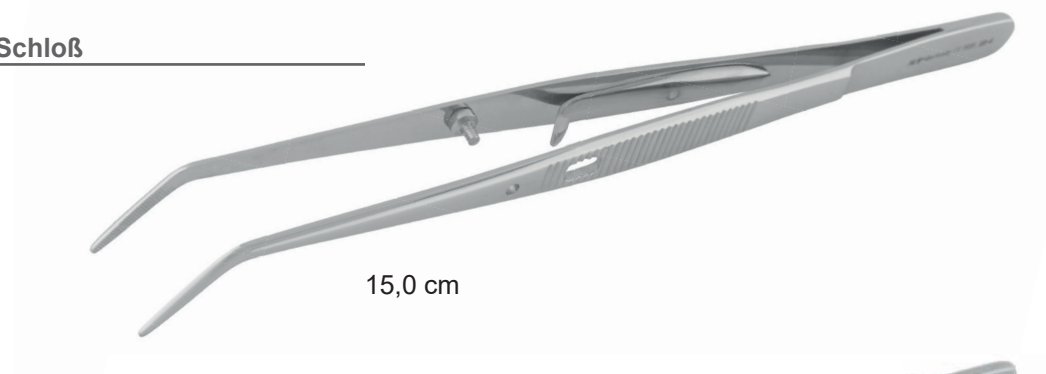

Pin-Pinzette

Ref. 22-5

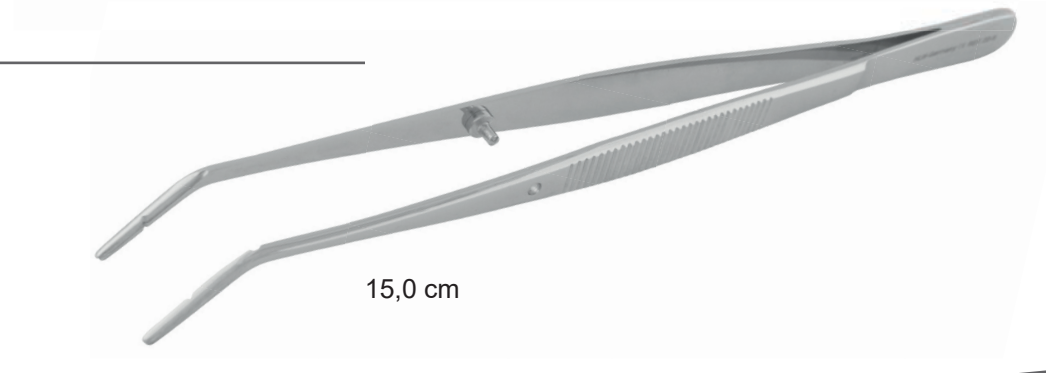

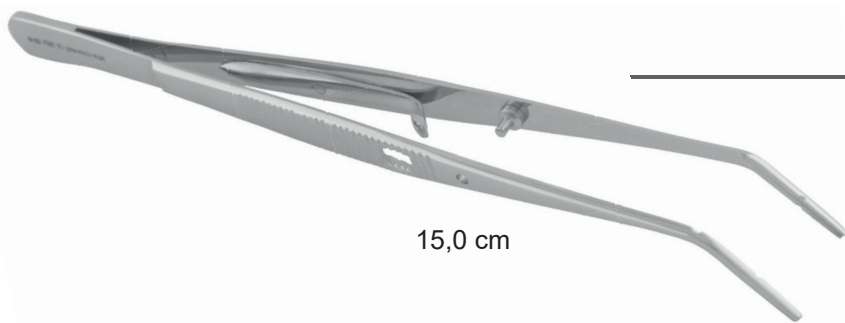

Pin-Pinzette mit Schloß

Ref. 22-6

15,0 cm

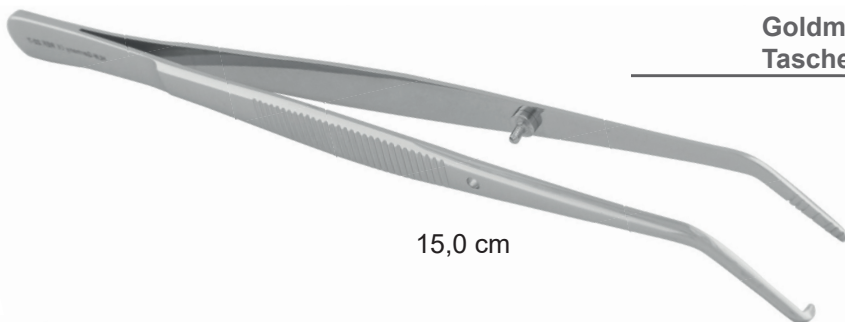

Goldman-Fox
Taschenmarkierpinzette rechts

Ref. 22-7

15,0 cm

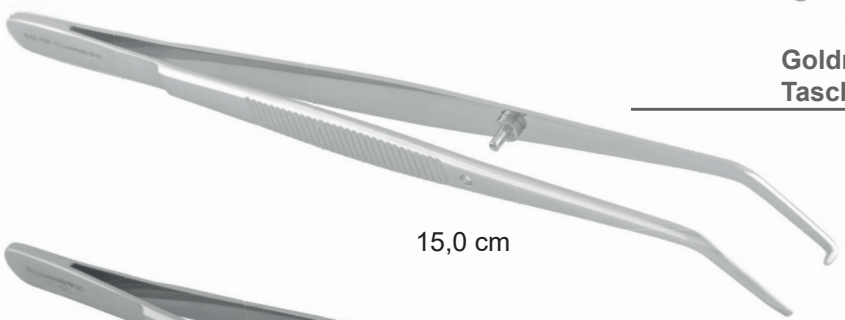

Goldman-Fox
Taschenmarkierpinzette links

Ref. 22-8

15,0 cm

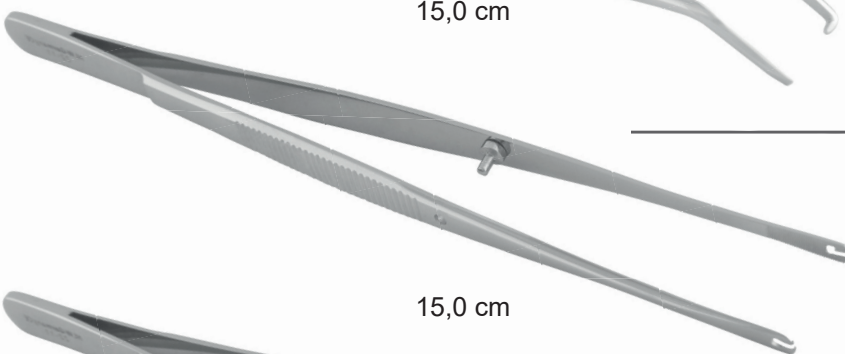

Nahtpinzette

Ref. 22-11

15,0 cm

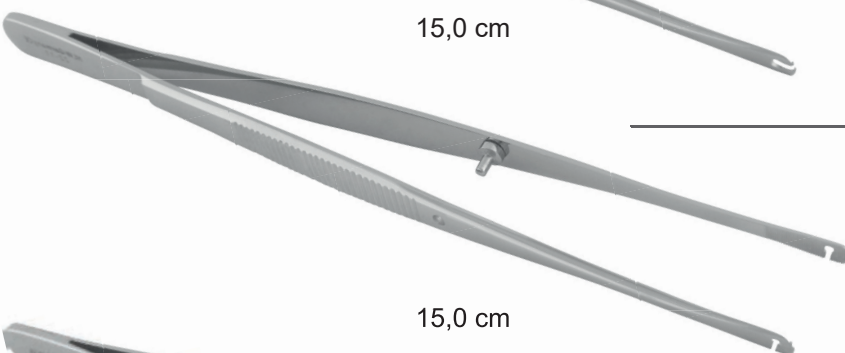

Nahtpinzette

Ref. 22-12

15,0 cm

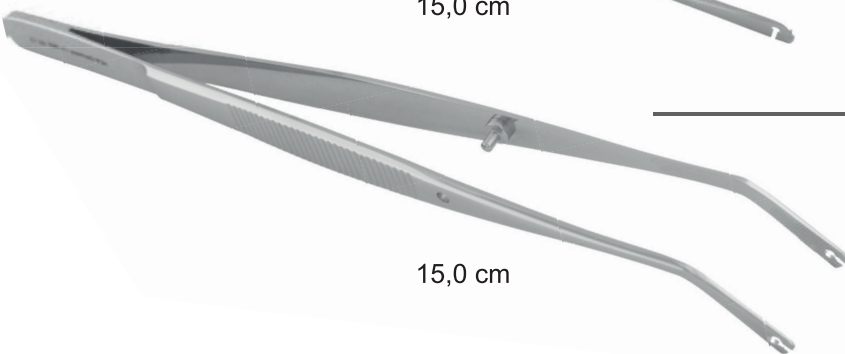

Nahtpinzette

Ref. 22-13

15,0 cm

Bestell-Nr.
Order-No.

Adson-Pinzette

anatomisch

Ref. 22-14



12,0 cm

Adson-Pinzette

chirurgisch

Ref. 22-15
Ref. 22-16A

gerade / straight
gebogen / curved

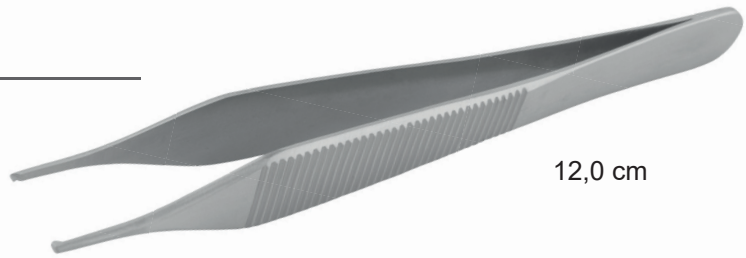

12,0 cm

Micro-Adson-Pinzette

ultra fein

Ref. 22-15A



12,0 cm

Chirurgische Pinzette

Ref. 22-17

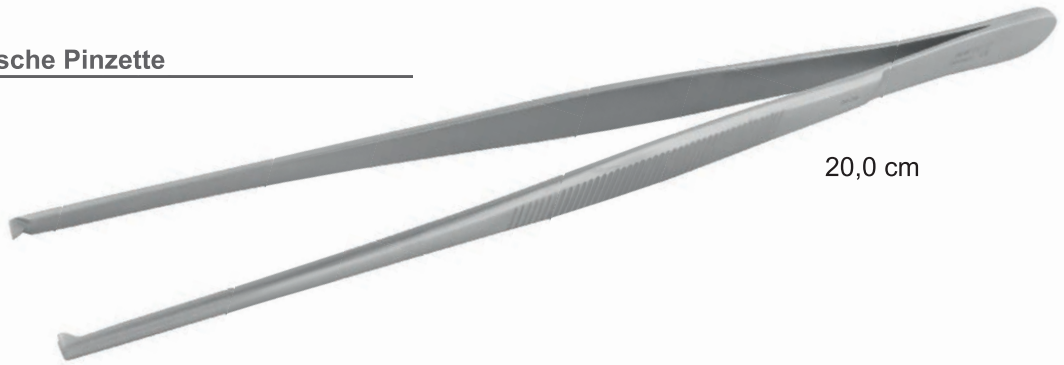

20,0 cm

Anatomische Pinzette

Ref. 22-18

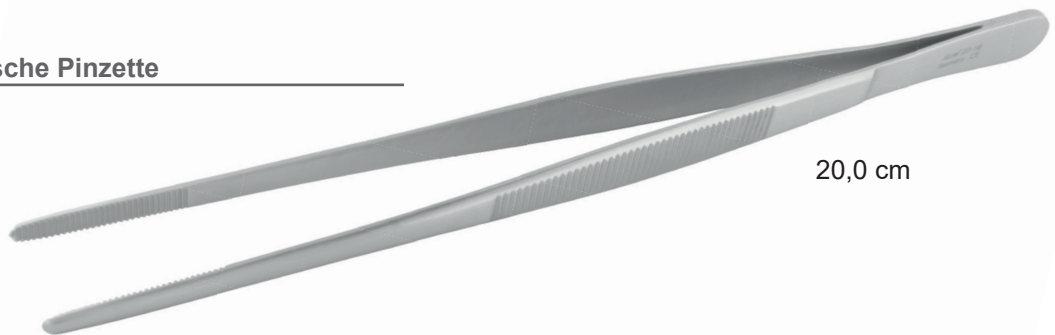

20,0 cm

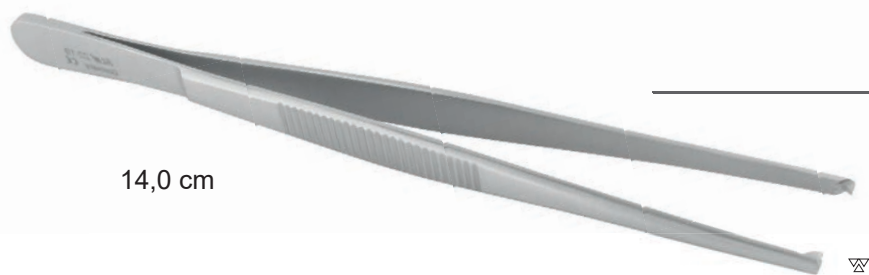

14,0 cm

Chirurgische Pinzette

Ref. 22-19



14,0 cm

Anatomische Pinzette

Ref. 22-20



12,5 cm

Anatomische Pinzette Semken

Ref. 22-21



12,5 cm

Chirurgische Pinzette Semken

Ref. 22-22

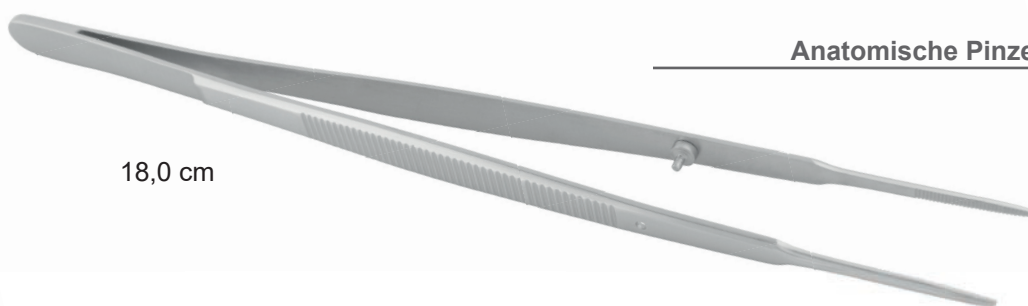

18,0 cm

Anatomische Pinzette Gerald

Ref. 22-21A

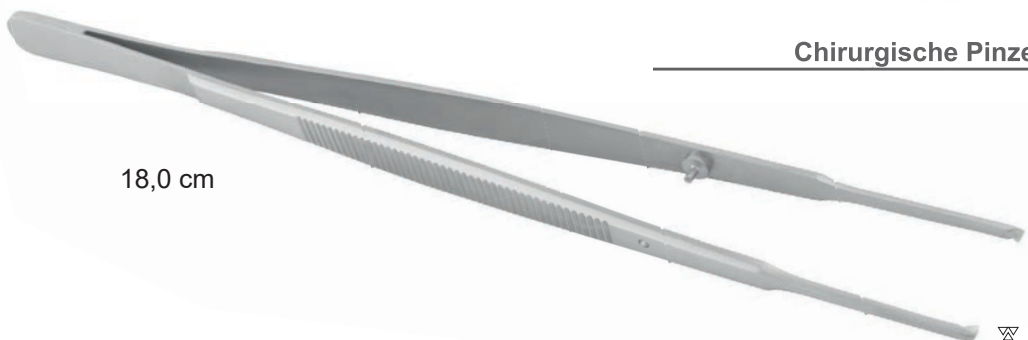

18,0 cm

Chirurgische Pinzette Gerald

Ref. 22-22A

Bestell-Nr.
Order-No.

Artikulationspinzette Miller

Ref. 22-23

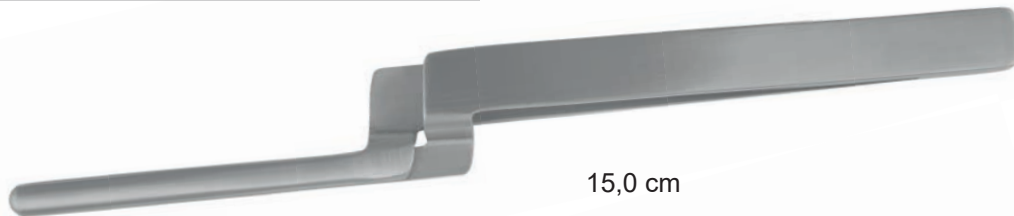

15,0 cm

Artikulationspinzette Miller

Ref. 22-23A

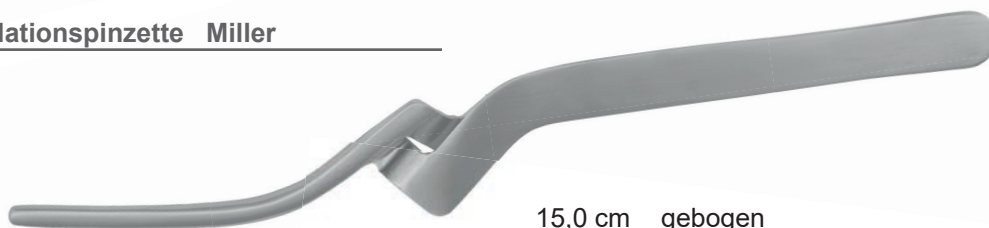

15,0 cm gebogen

Chirurgische Pinzette

Ref. 22-24



11,5 cm

Anatomische Pinzette

Ref. 22-25



11,5 cm

Collegepinzette

Ref. 22-26

starke Spitzen
strong tips

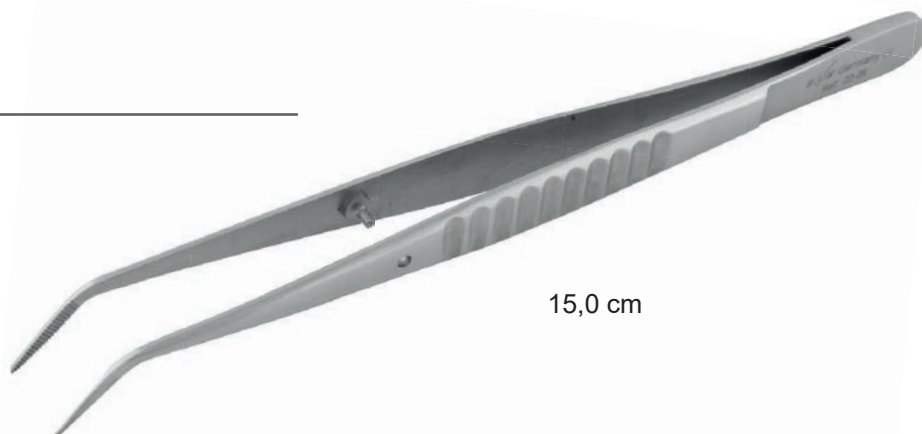

15,0 cm

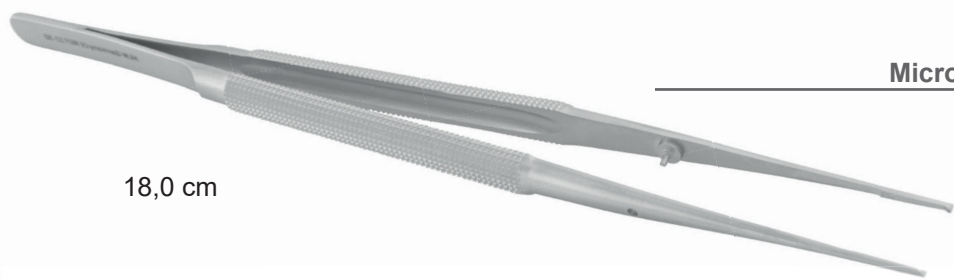

18,0 cm

Micro-Pinzette Gomet

chirurgisch gerade Ref. 22-30



18,0 cm

Micro-Pinzette Gomet

chirurgisch gebogen Ref. 22-31

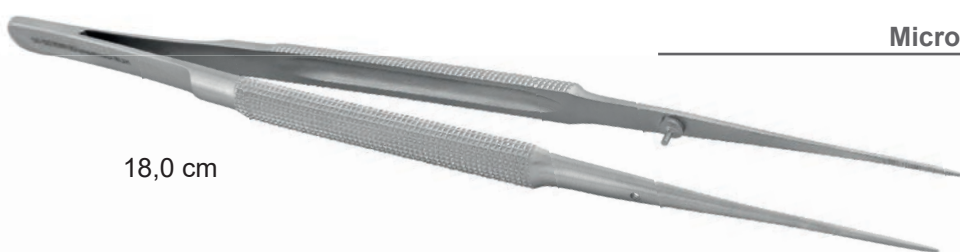

18,0 cm

Micro-Pinzette Gomet

anatomisch gerade Ref. 22-32

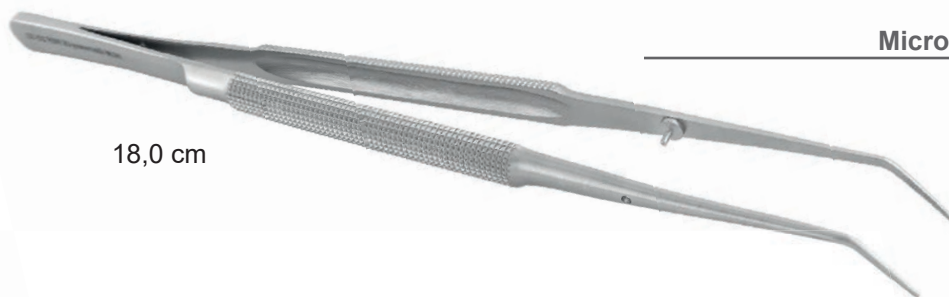

18,0 cm

Micro-Pinzette Gomet

anatomisch gebogen Ref. 22-33



15,0 cm

De Bakey

atraumatisch gerade Ref. 22-34



15,0 cm

De Bakey

atraumatisch gebogen Ref. 22-35

Bestell-Nr.
Order-No.

Haltepinzette mit Schloss gebogen

Ref. 22-36

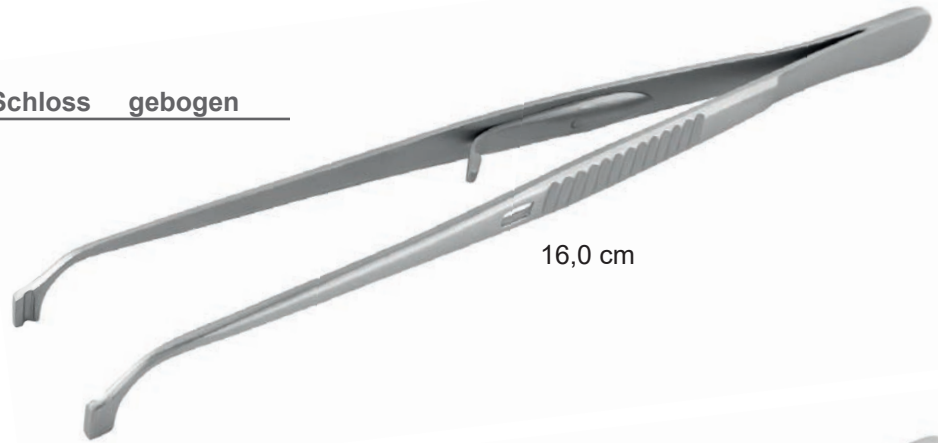

Mikrochirurgische Pinzette gerade

Ref. 22-41

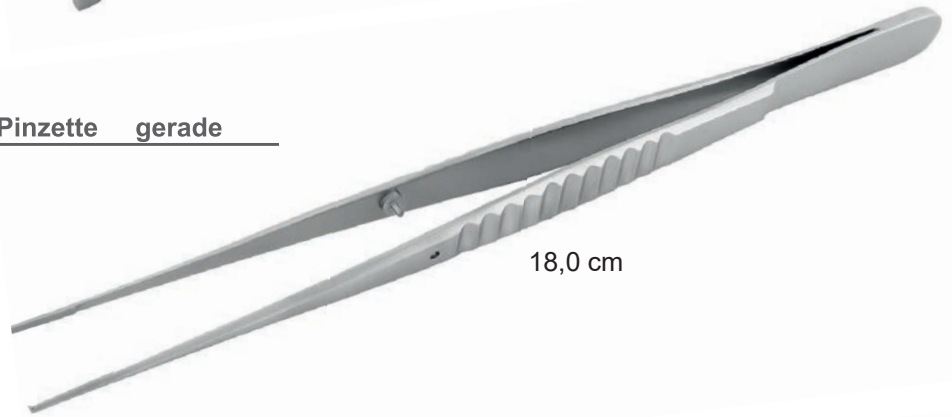

Mikrochirurgische Pinzette gebogen

Ref. 22-42

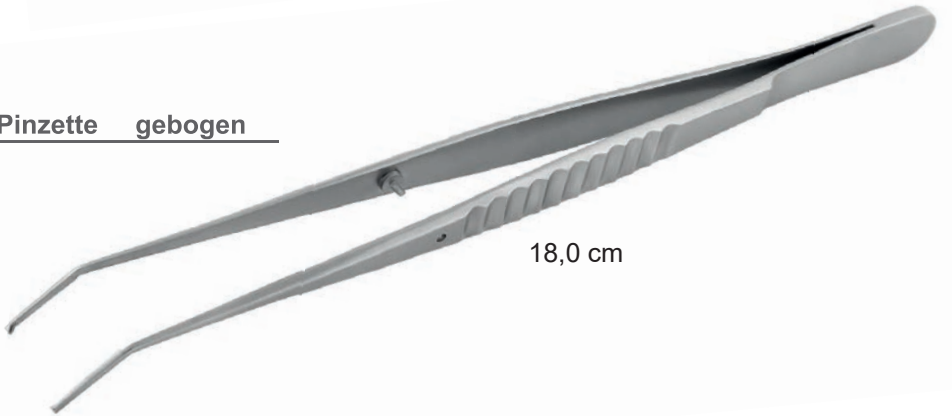

Mikrochirurgische Pinzette gerade

Ref. 40-97

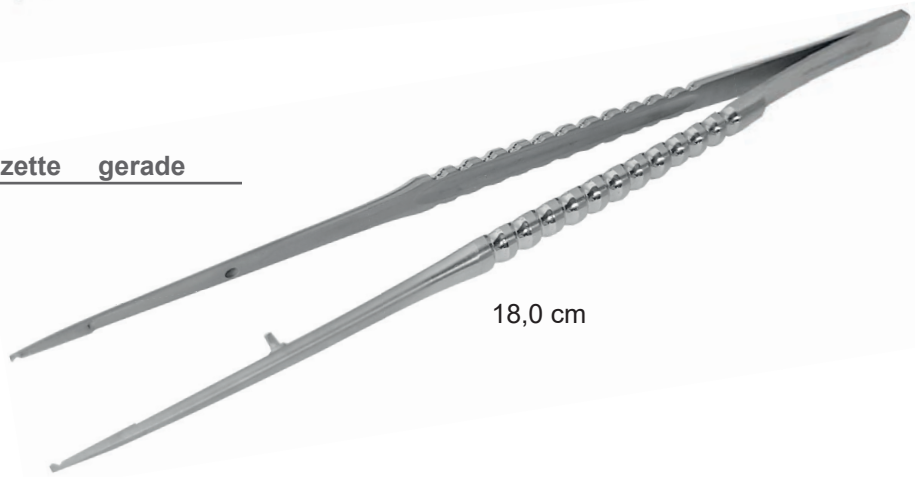

Mikro-Pinzette Cooley gerade

Ref. 40-98

18,0 cm

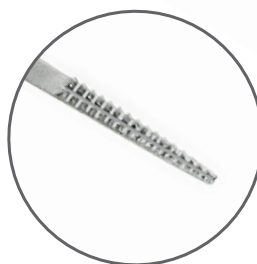

Mundspiegel

Mirrors

Spiegelgriffe

Mirror Handles

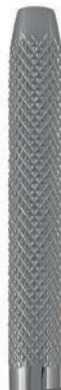

HLW Mundspiegel:

Hochwertige Qualität - rostfrei - nach allen bekannten Arten sterilisierbar bis 240° C
High quality mirrors - stainless - sterilizable to 240° C



Mundspiegel plan mirrors plane



Nr. 4 22,0 mm
12er Set Ref. 23-1

Nr. 5 24,0 mm
12er Set Ref. 23-2



Mundspiegel hohl mirrors magnifying



Nr. 4 22,0 mm
12er Set Ref. 23-3

Nr. 5 24,0 mm
12er Set Ref. 23-4



Mundspiegel rhodium rhodium plane



Nr. 4 22,0 mm
12er Set Ref. 23-5

Nr. 5 24,0 mm
12er Set Ref. 23-6

Bestell-Nr.
Order-No.

Mikrochirurgie-Spiegel Rhodium

Ref. 23-30

Ø 3,0 mm



Mikrochirurgie-Spiegel Rhodium

Ref. 23-31

Ø 5,0 mm



Mikrochirurgie-Spiegel Rhodium

Ref. 23-32

3,0 x 6,0 mm



Ergo-Mundspiegel Rhodium

Ref. 23-35

Ø 22,0 mm



Long-Mundspiegel Rhodium

Ref. 23-38

18,0 x 33,0 mm



Parallelometer Rhodium

Ref. 23-39



Doppelseitiger Mundspiegel Rhodium, plan

Ref. 23-40

Ø 24,0 mm

double side mirror



Rückseite

Hochwertige Rhodium Fotospiegel

- Beidseitig bespiegelt
- Glasstärke 3,0 mm
- sterilisierbar bis 134°C



Intra-Oral-Spiegel Intra Oral Mirrors

Bestell-Nr.
Order-No.

Lateral für Erwachsene

Maße:
Länge: 153,0 mm
Breite: 37,0 mm

Ref. 23-20

Lateral für Erwachsene

Maße:
Länge: 155,0 mm
Breite oben: 41,0 mm
Breite unten: 55,0 mm

Ref. 23-21

Occlusal für Erwachsene

Maße:
Länge: 138,0 mm
Breite oben: 70,0 mm
Breite unten: 63,0 mm

Ref. 23-22

Occlusal für Erwachsene

Maße:
Länge: 100,0 mm
Breite oben: 70,0 mm
Breite unten: 63,0 mm

Ref. 23-23

Occlusal für Kinder

Maße:
Länge: 84,0 mm
Breite oben: 60,0 mm
Breite unten: 43,0 mm

Ref. 23-24



Bestell-Nr.
Order-No.

Fingerform hohl - hollow

Ref. 23-7
extra leicht

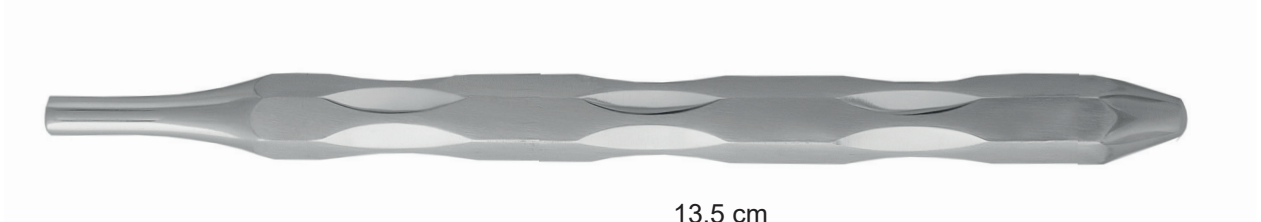

13,5 cm

Sechskant Edelstahl hohl - hollow

Ref. 23-8A
extra leicht



14,0 cm

Achtkant gerändelt - solid

Ref. 23-9



12,0 cm

Rundgriff gerändelt - solid round

Ref. 23-10



12,5 cm

Rundgriff hohl - hollow

Ref. 23-11
extra leicht



13,5 cm

Silikonschälmesser

Ref. 35-01

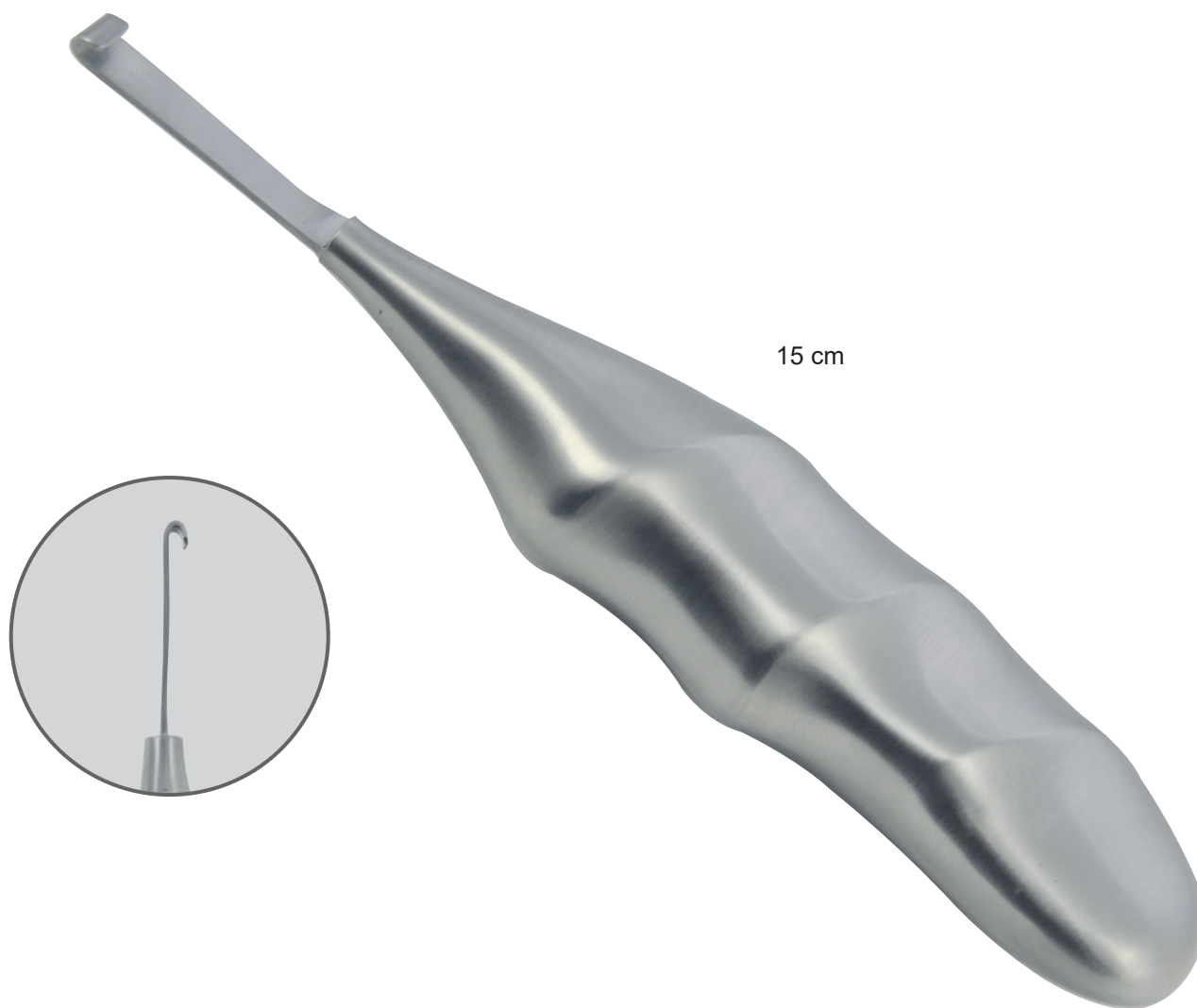

Füllungsinstrumente mit Titannitridbeschichtung

Filling Instruments
with Titanitrid Alloy

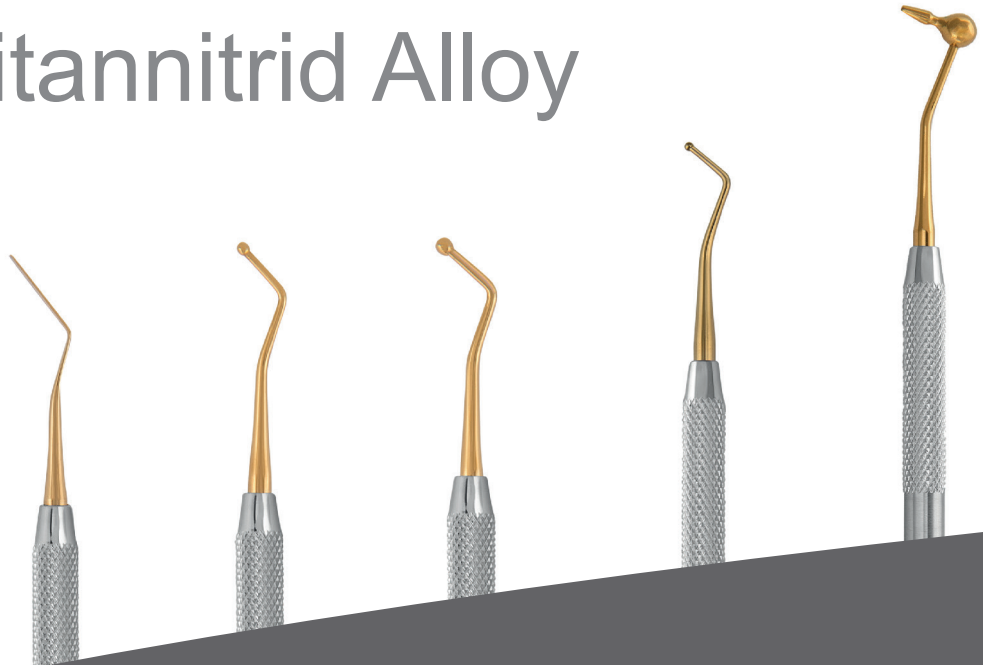



Bestell-Nr.
Order-No.

Ref. 24-6



Ref. 24-7



Ref. 24-8



Ref. 24-9



Ref. 24-10



Ref. 24-11



Scharfe Löffel

Bone Currettes

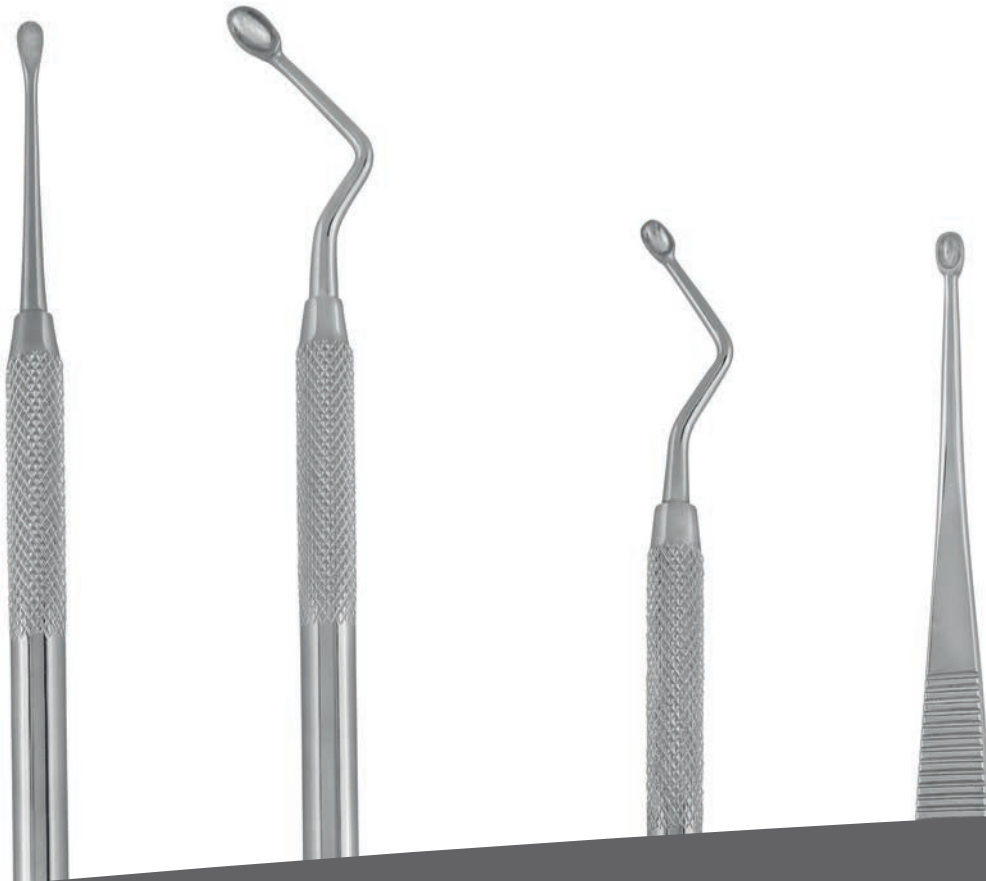

Bestell-Nr.
Order-No.

Lukas

Ref. 25-1

IC
3,0 mm



Lukas

Ref. 25-2

IC
4,0 mm



Lukas

Ref. 25-3

IC
2,0 mm



Lukas

Ref. 25-4

IC
3,0 mm



Lukas

Ref. 25-5

IC
4,0 mm



Williger

Ref. 25-6

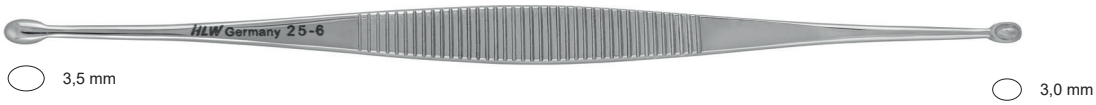

Williger

Ref. 25-7



Hemingway

Ref. 25-8



Hemingway

Ref. 25-9

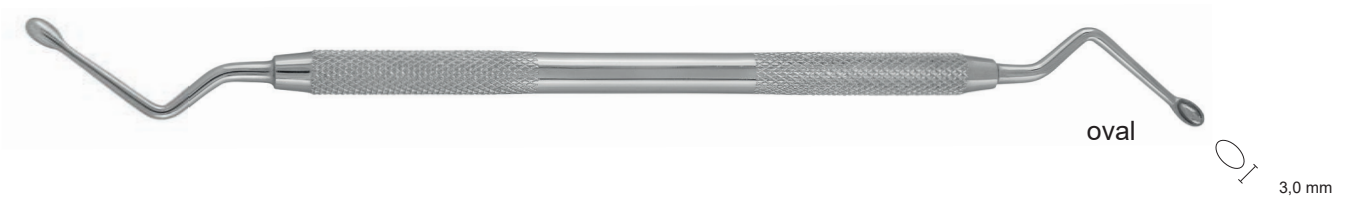

Hemingway

Ref. 25-10



Bestell-Nr.
Order-No.

Martin

Ref. 25-11

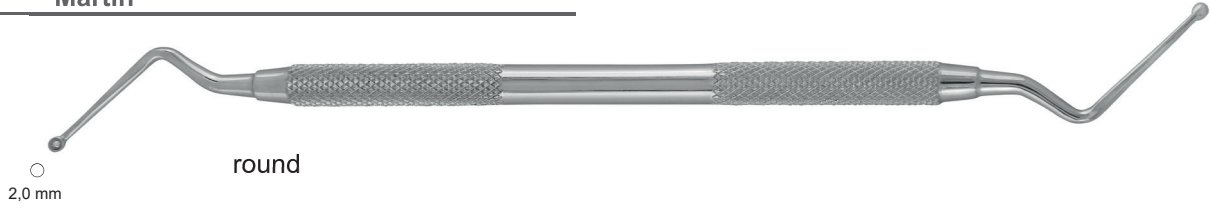

Martin

Ref. 25-12



Martin

Ref. 25-13



Hemingway

Ref. 25-14



Hemingway

Ref. 25-15

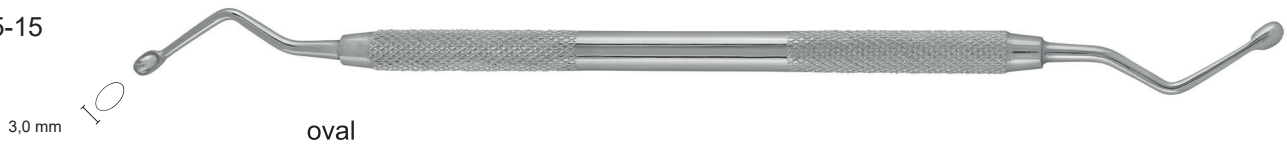

Hemingway

Ref. 25-16



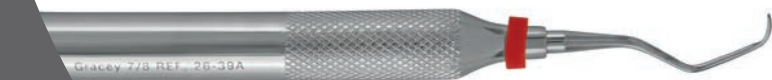

Küretten
Curettes

P.A. Scaler

Zahnreiniger
Scaler



Küretten Griffform „CLASSIC“
Curettes Handles “CLASSIC”



Küretten Griffform „DELUXE“
Curettes Handles “DELUXE”

Parodontologie-Instrumente
Periodontal Instruments



Microtools
Atraumatic
Extraktions-Set



Bestell-Nr.
Order-No.

Ref. 26-1

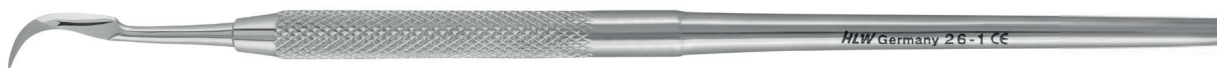

Ref. 26-2



Ref. 26-3

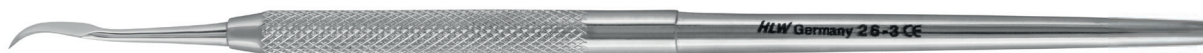

Ref. 26-4



Ref. 26-5

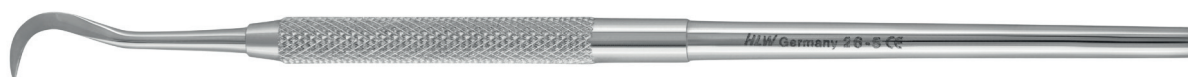



Ref. 26-6

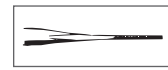

Ref. 26-7

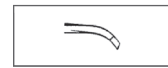
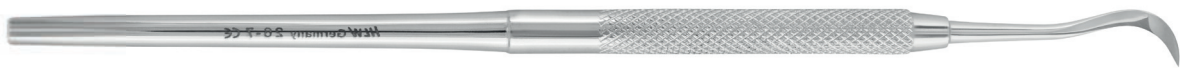

Ref. 26-8



Ref. 26-9



Ref. 26-10



Bestell-Nr.
Order-No.

Hohlgriff hollow handle Ø 8,0 mm

Taylor

Ref. 26-11



Fig. T 2/3

Ref. 26-12



Fig. CI 2/3

McCall

Ref. 26-14



Fig. 13S/14S

McCall

Ref. 26-15



Fig. 13/14

McCall

Ref. 26-15A



Fig. 17/18

Towner Jaquette

Ref. 26-16



Fig. 15/30

Towner Jaquette

Ref. 26-17



Fig. 5/33

Hohlgriff hollow handle Ø 8,0 mm

Jaquette



Ref. 26-18

Fig. 30/33

Hygenist



Ref. 26-19

Fig. H6/H7

Younger Good



Ref. 26-20

Fig. 7/8

Scaler



Ref. 26-56

Fig. 204 S

Scaler



Ref. 26-57

Fig. 204 SD

Scaler



Ref. 26-62

Fig. M 23

Bestell-Nr.
Order-No.

Hohlgriff hollow handle Ø 8,0 mm

Kürette

Ref. 26-63



Fig. M 23A

Kirkland

Ref. 26-27

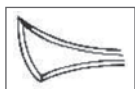

Fig. 15/16

Columbia

Ref. 26-28



Fig. 4 R/L

Columbia

Ref. 26-29



Fig. 2 R/L

Columbia

Ref. 26-30



Fig. 13/14

Columbia

Ref. 26-31



Fig. 411/412

Columbia

Ref. 26-32



Fig. 413/414

Hohlgriff hollow handle Ø 8,0 mm

Langer

Ref. 26-33



Fig. 1/2

Langer

Ref. 26-34



Fig. 5/6

Langer

Ref. 26-35



Fig. 3/4

Gracey

Ref. 26-36



Fig. 1/2

Gracey

Ref. 26-37



Fig. 3/4

Gracey

Ref. 26-38



Fig. 5/6

Bestell-Nr.
Order-No.

Hohlgriff hollow handle Ø 8,0 mm

Gracey

Ref. 26-39



Fig. 7/8

Gracey

Ref. 26-40



Fig. 9/10

Gracey

Ref. 26-41



Fig. 11/12

Gracey

Ref. 26-42



Fig. 13/14

Gracey

Ref. 26-43



Fig. 15/16

Gracey

Ref. 26-44



Fig. 17/18

Küretten Griffform Ç LASSIC“ Curettes Handles „CLASSIC“

Bestell-Nr.
Order-No.

Hohlgriff hollow handle Ø 10,0 mm extra leicht

Gracey



Ref. 26-36A

Fig. 1/2

Gracey



Ref. 26-37A

Fig. 3/4

Gracey



Ref. 26-38A

Fig. 5/6

Gracey



Ref. 26-39A

Fig. 7/8

Gracey



Ref. 26-40A

Fig. 9/10

Gracey



Ref. 26-41A

Fig. 11/12



Bestell-Nr.
Order-No.

Hohlgriff hollow handle Ø 10,0 mm extra leicht

Gracey

Ref. 26-42A



Fig. 13/14

Gracey

Ref. 26-43A



Fig. 15/16

Gracey

Ref. 26-44A



Fig. 17/18

Küretten Griffform D ELUXE“

Curettes Handles „DELUXE“

Gracey

Ref. 26-36B



Fig. 1/2

Gracey

Ref. 26-37B



Fig. 3/4

Gracey

Ref. 26-38B



Fig. 5/6

Küretten Griffform D „ELUXE“ Curettes Handles „DELUXE“

Bestell-Nr.
Order-No.

Hohlgriff hollow handle Ø 10,0 mm extra leicht

Gracey

Ref. 26-39B



Fig. 7/8

Gracey

Ref. 26-40B



Fig. 9/10

Gracey

Ref. 26-41B



Fig. 11/12

Gracey

Ref. 26-42B



Fig. 13/14

Gracey

Ref. 26-43B



Fig. 15/16

Gracey

Ref. 26-44B



Fig. 17/18

Bestell-Nr.
Order-No.

Gracey MF = mit kurzem Arbeitsende, Hohlgriff Ø 10,0 mm extra leicht

Gracey MF

Ref. 26-36B MF



Fig. 1/2

Gracey MF

Ref. 26-38B MF



Fig. 5/6

Gracey MF

Ref. 26-39B MF



Fig. 7/8

Gracey MF

Ref. 26-41B MF



Fig. 11/12

Gracey MF

Ref. 26-42B MF



Fig. 13/14

Codierringe zur Markierung von Küretten

Bestell-Nr.
Order-No.



braun
50 Stück

Ref. 26-001



gelb
50 Stück

Ref. 26-002



grün
50 Stück

Ref. 26-003



grau
50 Stück

Ref. 26-004



schwarz
50 Stück

Ref. 26-005



rot
50 Stück

Ref. 26-006



blau
50 Stück

Ref. 26-007



weiss
50 Stück

Ref. 26-008



Bestell-Nr.
Order-No.

Griffform **Ç** LASSIC; Hohlgriff, Ø 10,0 mm extra leicht

Langer

Ref. 26-33A



Fig. 1/2

Langer

Ref. 26-34A



Fig. 5/6

Langer

Ref. 26-35A



Fig. 3/4

Griffform **D** ELUXE; Hohlgriff, Ø 10,0 mm extra leicht

Langer

Ref. 26-33B



Fig. 1/2

Langer

Ref. 26-34B



Fig. 5/6

Langer

Ref. 26-35B



Fig. 3/4

CLASSIC Hohlgriff Ø 10,0 mm extra leicht

Taylor

Fig. T2/3



Ref. 26-11A

Hygenist

Fig. H6/H7



Ref. 26-19A

Fig. 204S



Ref. 26-56A

Fig. 204SD



Ref. 26-57A

McCall

Fig. 13S/14S



Ref. 26-14A

DELUXE Hohlgriff Ø 10,0 mm extra leicht

Taylor

Fig. T2/3



Ref. 26-11B

Hygenist

Fig. H6/H7



Ref. 26-19B

Fig. 204S



Ref. 26-56B

Fig. 204SD



Ref. 26-57B

Bestell-Nr.
Order-No.

Periotome Hohlgriff Ø 10,0 mm extra leicht

Ref. 26-60

PT 1



Zur atraumatischen Extraktion von Implantaten, schont Weichgewebe und Knochen.

Ref. 26-61

PT 2



Gingivektomiemesser ORBAN Knife

Ref. 26-64



Knochenfeile Hohlgriff Ø 10,0 mm extra leicht

Schugger

Ref. 26-65



P.A. Meißel

Ochsenbein Fig. 1

Ref. 26-25



16,5 cm



Ochsenbein Fig. 2

Ref. 26-26



16,5 cm



P.A. Scaler & Küretten Hohlgriff Ø 10,0 mm extra leicht

Scaler



M 23

Ref. 26-62B

Scaler McCall



13/14

Ref. 26-15B

Scaler McCall



13S/14S

Ref. 26-14A

Kürette Columbia



2R/2L

Ref. 26-29A

Kürette Columbia



4R/4L

Ref. 26-28A

Zahnsonden Probes

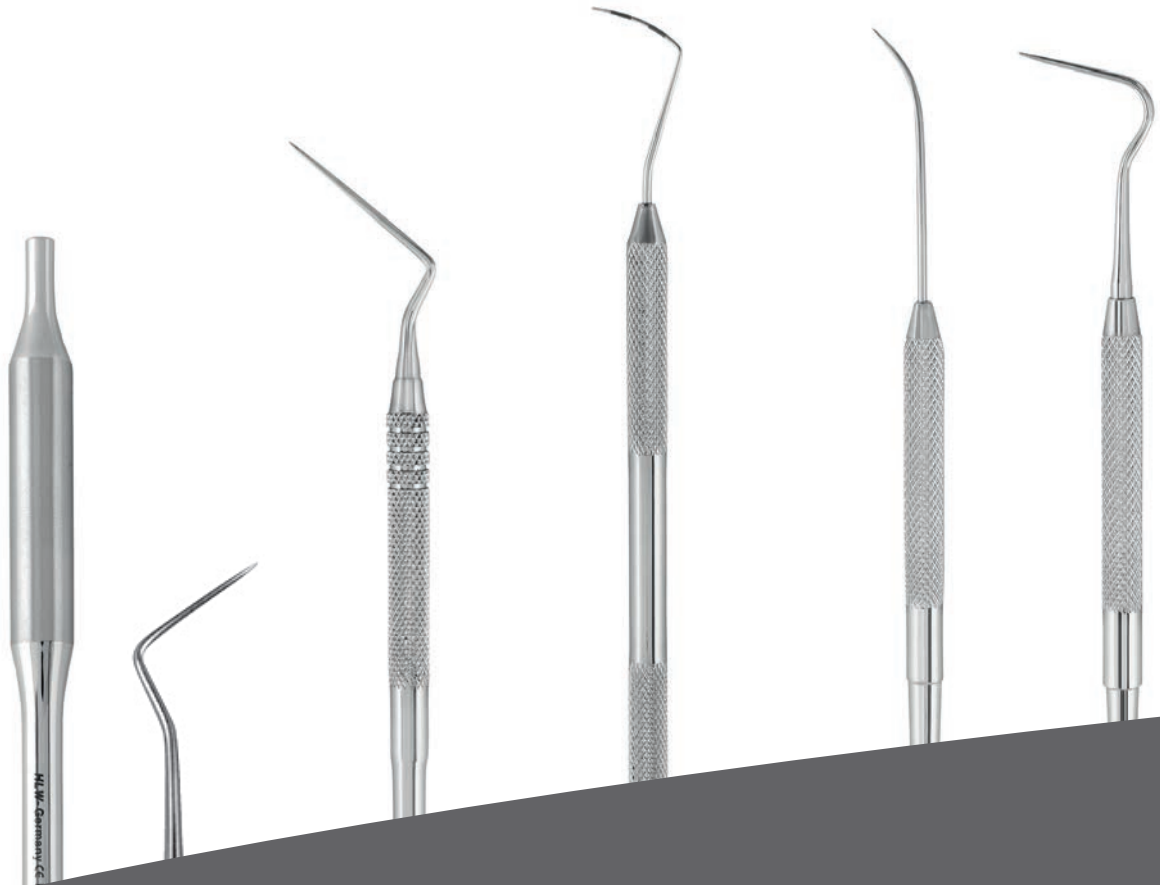

Messsonden

P.A. Probes

Wurzelkanalerweiterer

Spreaders

Zahnsonden mit auswechselbaren Spitzen

12,5 cm



Rundgriff gerändelt - solid round

Ref. 23-10

13,5 cm



Rundgriff hohl - hollow

extra leicht

Ref. 23-11



Ref. 27-9E



Ref. 27-11E



Ref. 27-7E



Ref. 27-8E



Ref. 27-13E



Ref. 27-12E

Bestell-Nr.
Order-No.

Ref. 27-1



starr / non flexible

Fig. 6

Ref. 27-2



starr / non flexible

Fig. 8

Ref. 27-3



starr / non flexible

Fig. 9

Ref. 27-4



starr / non flexible

Fig. 18

Ref. 27-5



starr / non flexible

Fig. 17

Ref. 27-6



starr / non flexible

Fig. 23

Ref. 27-7



flexible

Fig. 32



Fig. 33

Ref. 27-8



Fig. 65

Ref. 27-9



Fig. 39

Ref. 27-10



Fig. 30

Ref. 27-11



Fig. 23

Ref. 27-12



Fig. 17

Ref. 27-13



Fig. 3A

Ref. 27-3A

Bestell-Nr.
Order-No.

Ref. 27-14



flexible

Fig. 6/23

Ref. 27-15



flexible

Fig. 17/23

Ref. 27-15A

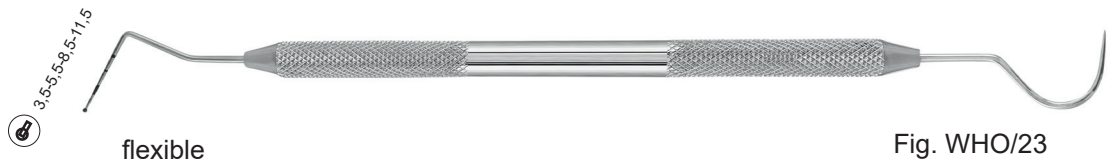

flexible

Fig. WHO/23

Farbcodiert
kugelförmiges Arbeitsende

Ref. 27-16



flexible

Fig. 6/17

Ref. 27-17



flexible

Fig. 6/1

Ref. 27-24A



Furkationssonde

WHO



Goldman-Fox



Williams



CP 12



PCPUNC15



Goldman-Fox / Williams



Nabers



Nabers



Bestell-Nr.
Order-No.

Spreader

Ref. 27-25



Spreader

Ref. 27-26



Spreader

Ref. 27-27



Spreader

Ref. 27-28



Wurzelkanalstopfer Root Canal Plugger

Plugger

Ref. 27-31

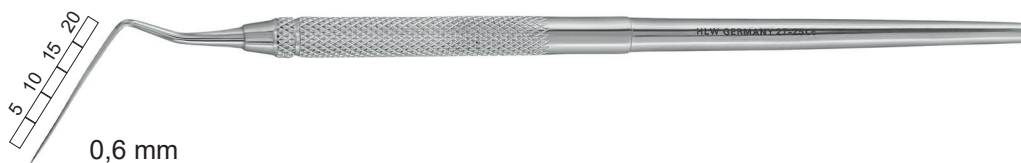

Plugger

Ref. 27-32



Plugger

Ref. 27-33

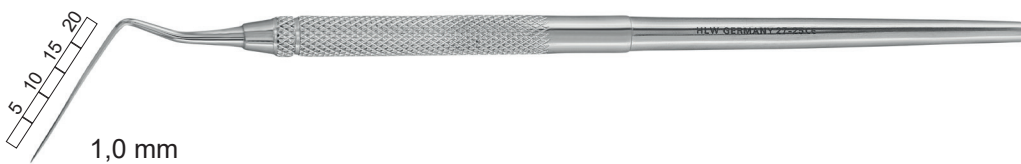

Plugger

Ref. 27-34

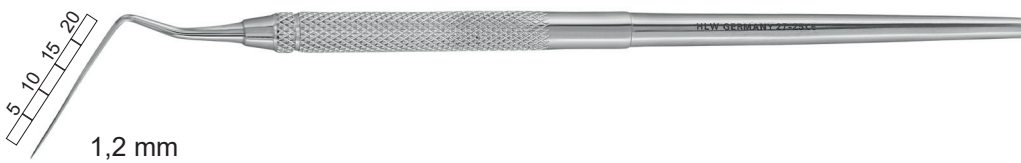

Excavator Excavators

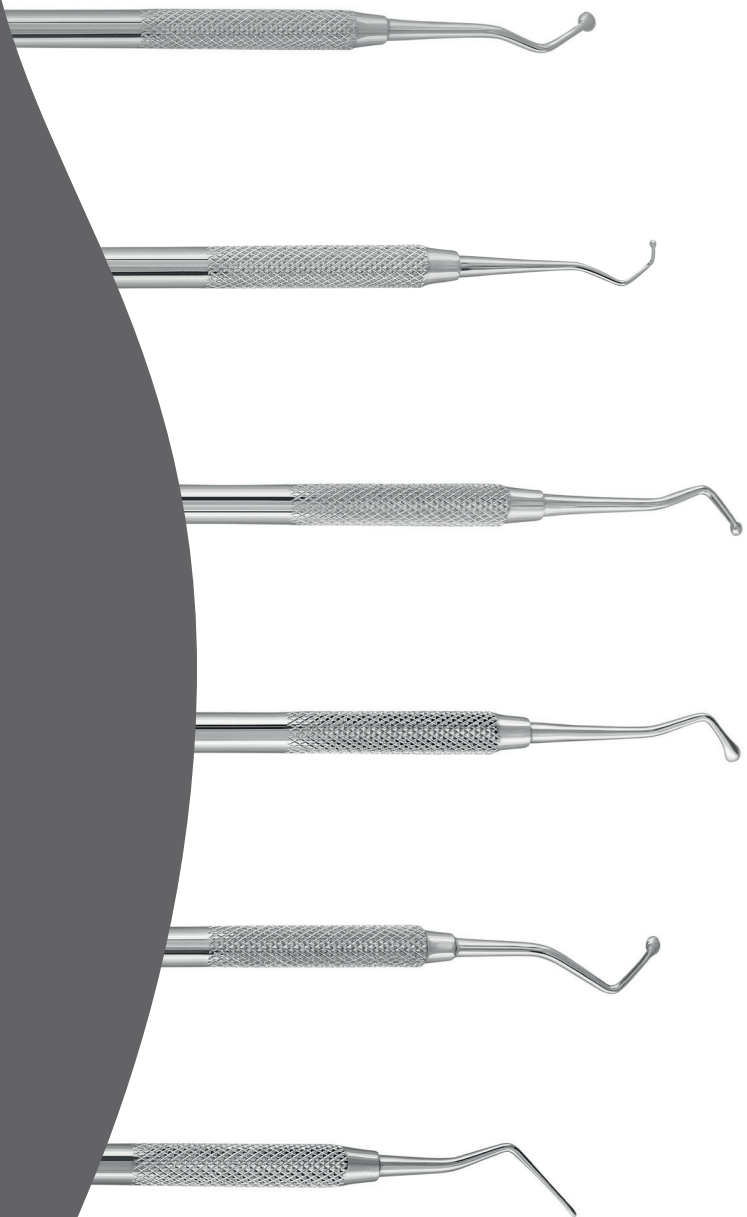

Bestell-Nr.
Order-No.

Ref. 28-1



Ref. 28-2



Ref. 28-3



Ref. 28-4



Ref. 28-5



Ref. 28-6



Ref. 28-7





○
2,0 mm round

Ref. 28-8



○
2,0 mm round

Ref. 28-9



○
2,5 mm round

Ref. 28-10



○
1,5 mm round

Ref. 28-11



○
1,0 mm round

Ref. 28-12



○
2,0 mm round

Ref. 28-13



○
1,5 mm round

Ref. 28-14

Bestell-Nr.
Order-No.

Ref. 28-15



Ref. 28-16



Ref. 28-17



Ref. 28-18



Ref. 28-19



Ref. 28-20



Ref. 28-21



Ref. 28-22



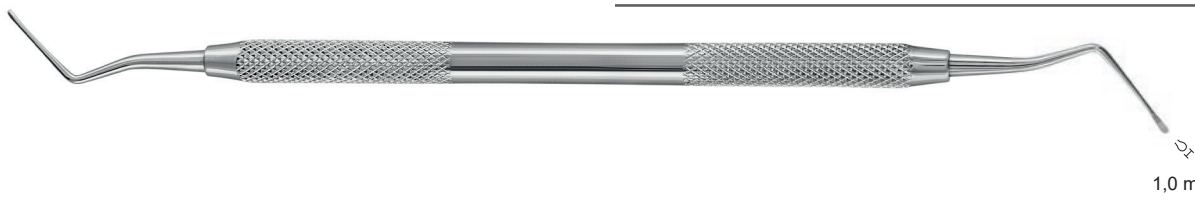

Füllungsinstrumente

Filling Instruments

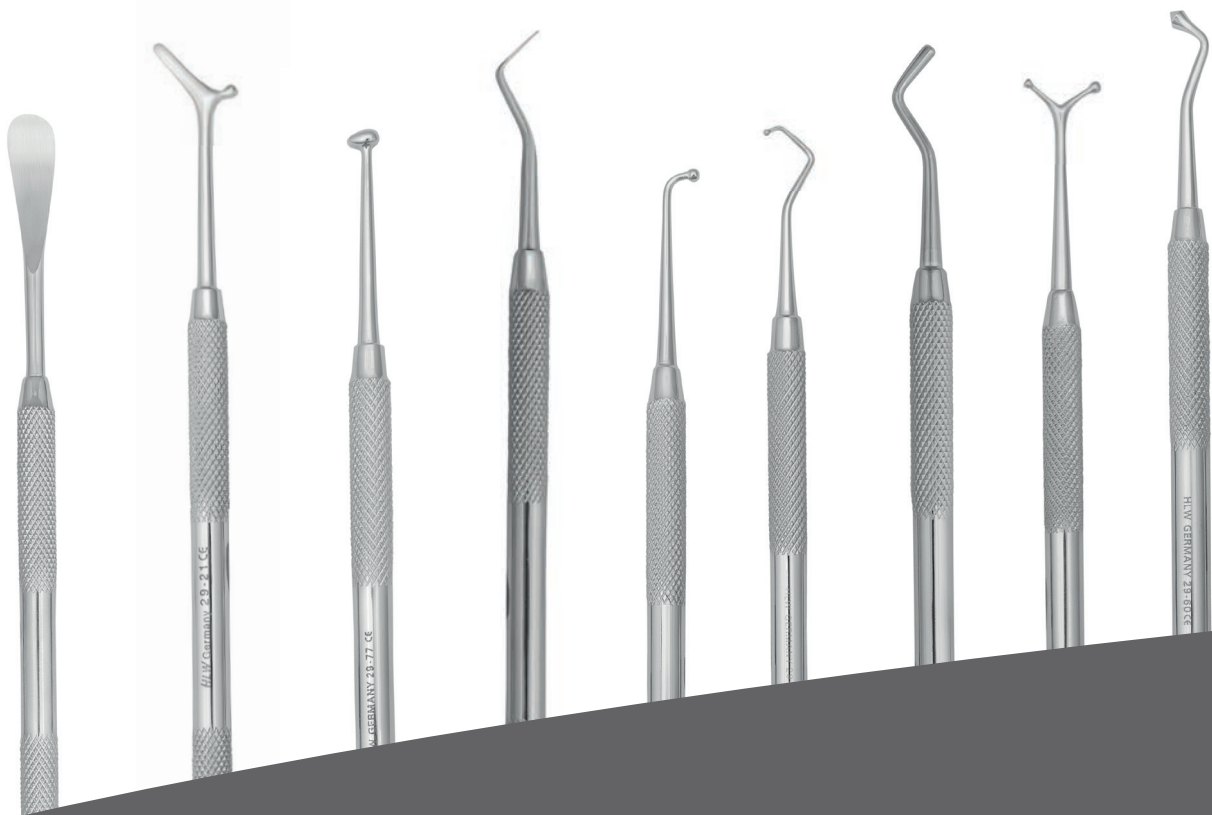

Amalgaminstrumente
Amalgam Instruments

Heidemann



Ref. 29-1

flexible

2,0 mm

Heidemann



Ref. 29-2

flexible

2,5 mm

Heidemann



Ref. 29-3

flexible

3,0 mm



Ref. 29-4

non flexible

1,5 mm



Ref. 29-5

non flexible

2,0 mm



Ref. 29-6

non flexible

2,5 mm



Ref. 29-7

non flexible

3,0 mm

Bestell-Nr.
Order-No.

Ref. 29-8



Ref. 29-9



Ref. 29-10



Ref. 29-11



Ref. 29-12



Ref. 29-13



Ref. 29-14





Ref. 29-15



Ref. 29-16



Ref. 29-17



Ref. 29-18



Ref. 29-19

VAJNA



Ref. 29-21



Ref. 29-22

∅ 1,0 mm

Bestell-Nr.
Order-No.

Ref. 29-23



Ref. 29-24



Ref. 29-25



Ref. 29-26



Ref. 29-27



Ref. 29-28



Ref. 29-29





Ref. 29-30



Ref. 29-31

VAJNA



Ref. 29-32

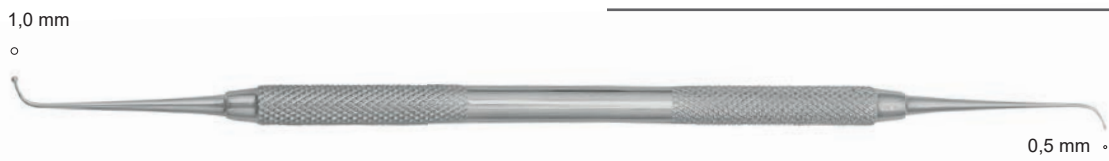

Ref. 29-33



Ref. 29-34

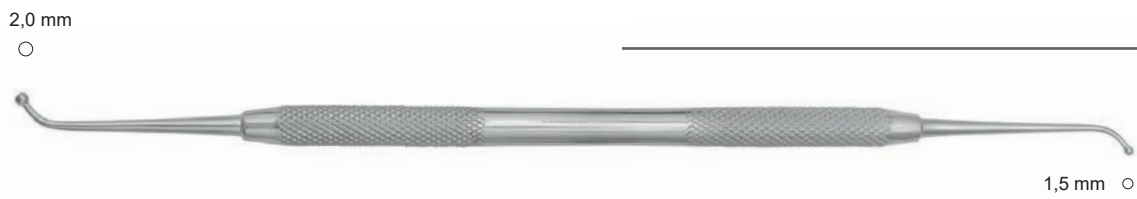

Ref. 29-35

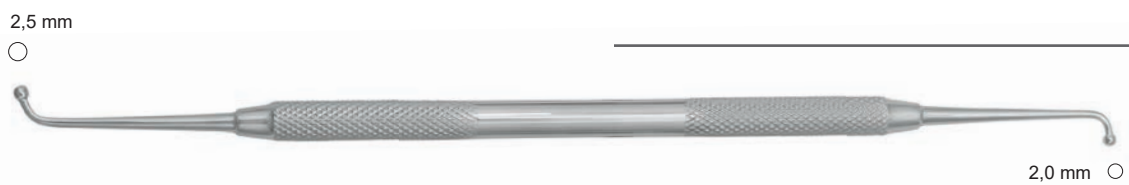

Ref. 29-36

Bestell-Nr.
Order-No.

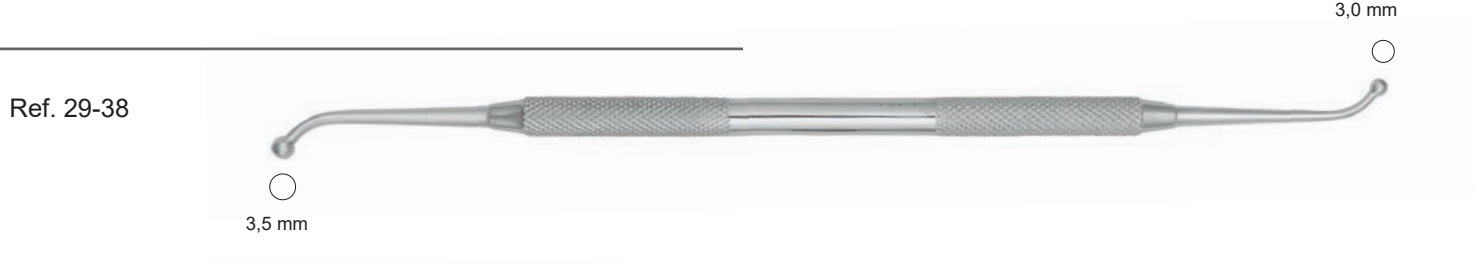
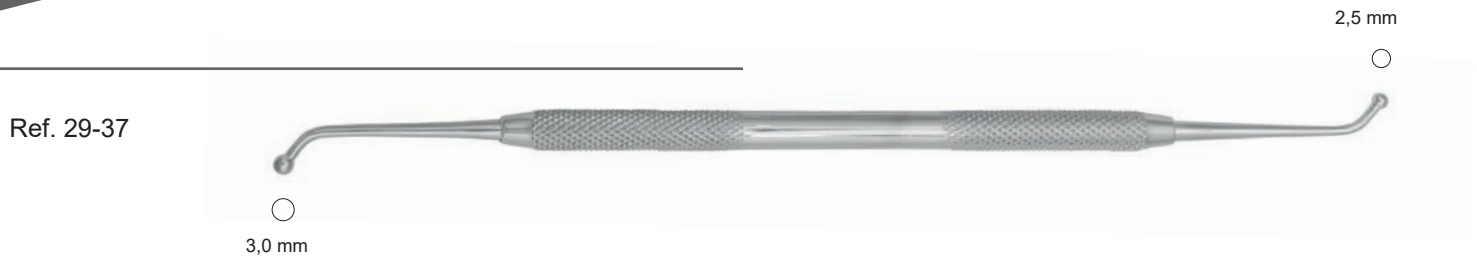

○ 2,0 mm



Ref. 29-45

○ 3,0 mm



Ref. 29-46

○ 1,0 mm



Ref. 29-47

○ 2,0 mm



Ref. 29-48

○ 1,5 mm



Ref. 29-49

○ 1,5 mm

Planstopfer



Ref. 29-50

○ 2,0 mm

Planstopfer



Ref. 29-51

○ 2,5 mm

Planstopfer



Ref. 29-52

Bestell-Nr.
Order-No.

Ref. 29-53



Ref. 29-54



Ref. 29-55



Ref. 29-56



Ref. 29-57



Ref. 29-58



Ref. 29-59



Ref. 29-60



Hollenback

Ref. 29-61



Bennet

Ref. 29-62



Mortonson



Ref. 29-63

Hollenback



Ref. 29-64

Hollenback



Ref. 29-65

Cleoid-Discoïd



Ref. 29-66

Frahm



Ref. 29-67

Beale



Ref. 29-68

Beale



Ref. 29-69

Placement



Ref. 29-70

Tamponstopfer



Ref. 29-71

Retraktionsfadenleger



Ref. 29-72

Bestell-Nr.
Order-No.

Lösche

Ref. 29-73



Planator

Ref. 29-74



Gingivalanschräger

Ref. 29-75



mesial

Gingivalanschräger

Ref. 29-76



distal

Brünierer

Ref. 29-77



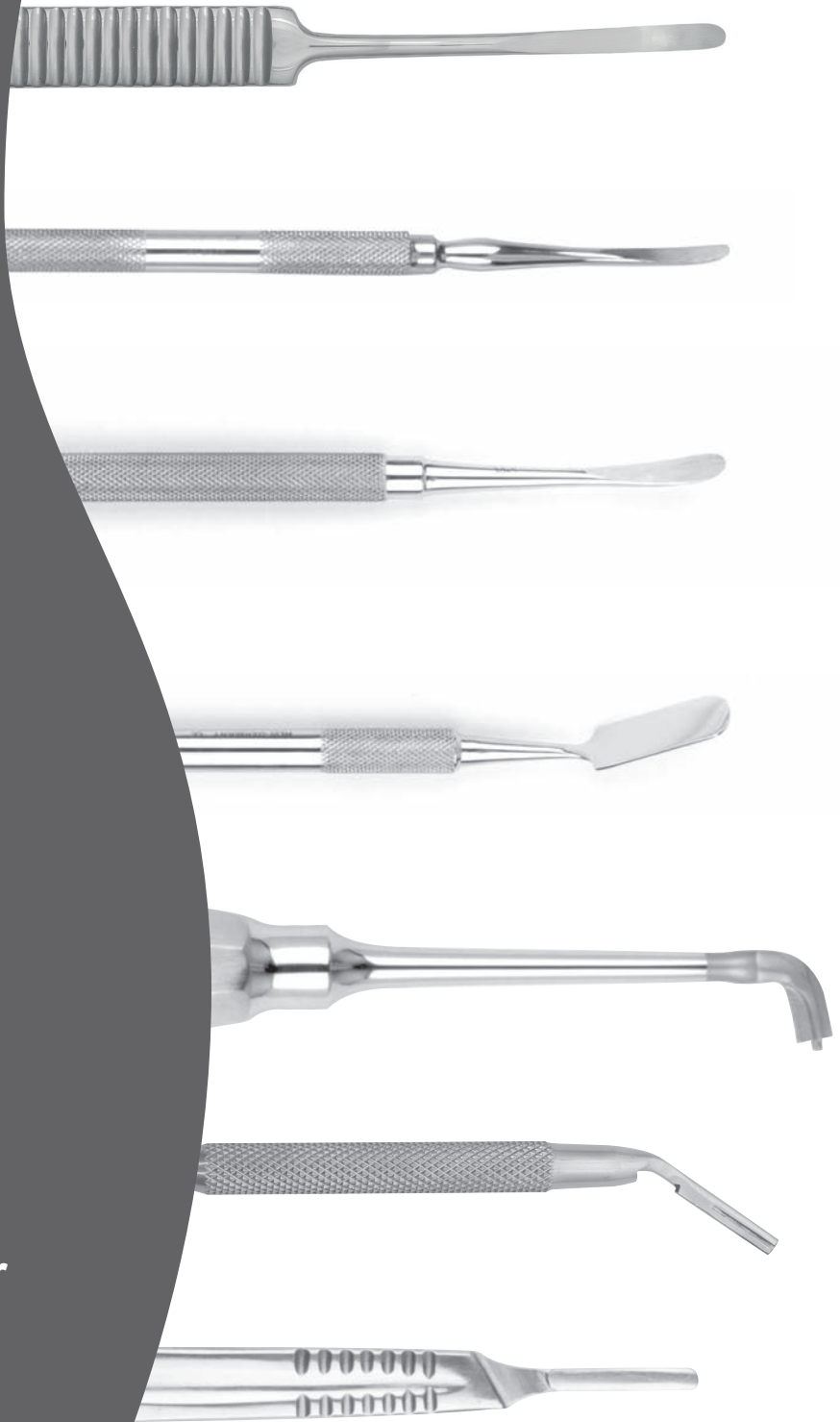

Raspatoren
Raspatories

Kronenaufbieger
Crown Bender

Skalpellgriffe
Scalpel Handle

Bestell-Nr.
Order-No.

Williger

Ref. 30-1

6,0 mm



12,5 cm

Williger

Ref. 30-2

7,0 mm



16,0 cm

Williger

Ref. 30-2A 4,0mm



Ref. 30-2B 5,0mm

16,0 cm

Molt

Ref. 30-3

6,0 mm



6,0 mm

17,5 cm

Molt

Ref. 30-4

6,0 mm



4,5 mm

17,5 cm

Meat

Ref. 30-5

6,5 mm



7,0 mm

17,5 cm

Meat

Ref. 30-5A

3,5 mm



3,5 mm

17,5 cm

Meat

Ref. 30-5B

2,5 mm



2,5 mm

17,5 cm

Freer

Ref. 30-6

5,0 mm
blunt



5 mm
sharp

17,5 cm

Freer



Ref. 30-6A

Freer



Ref. 30-7

Prichard



Ref. 30-15

Seldin



Ref. 30-16

Seldin



Ref. 30-17

Bestell-Nr.
Order-No.

Ref. 30-8

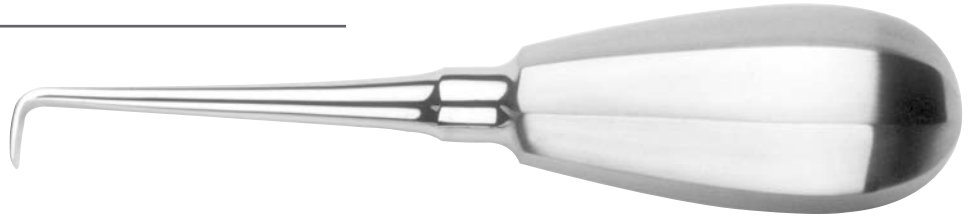
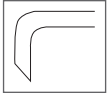

Ref. 30-8A

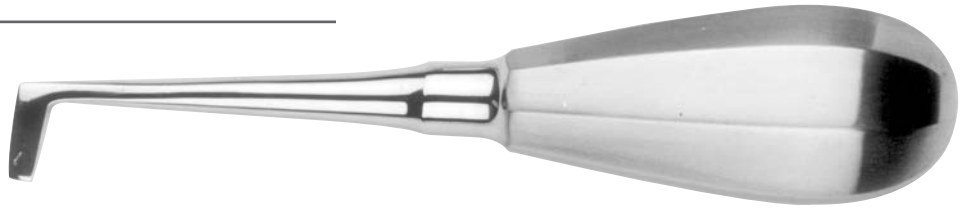

Universal

Ref. 30-8B

+

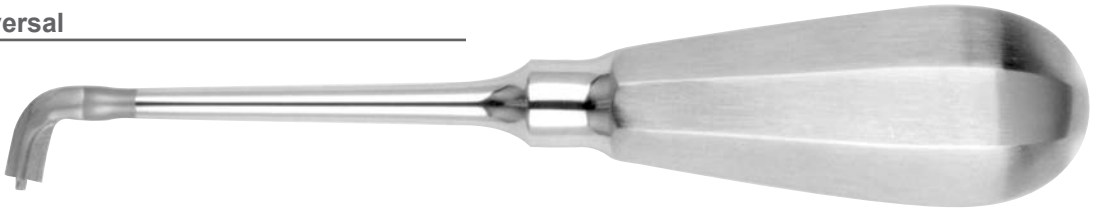

Ref. 30-8C

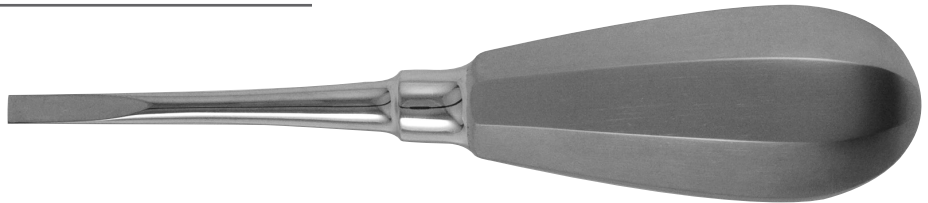

Kronenspreizzange / Crown spreader

Ref. 30-8D

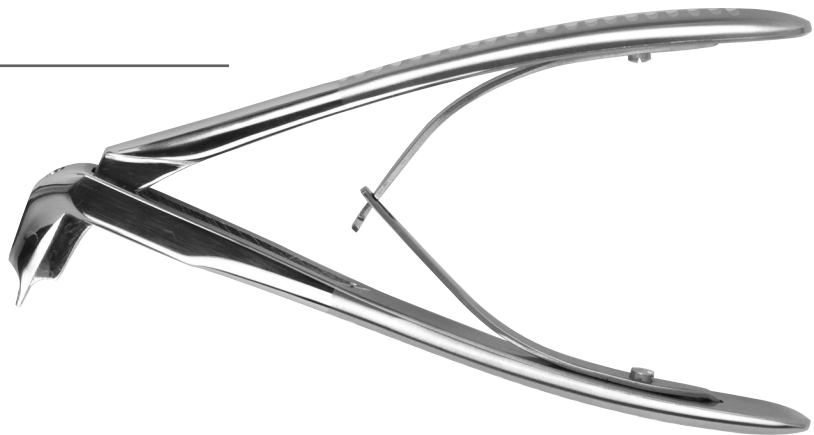
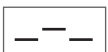

Skalpellgriffe
Scalpel Handle

Bestell-Nr.
Order-No.

Nr. 3



Ref. 30-9

Nr. 3A



Ref. 30-9A

Nr. 4



Ref. 30-10

Nr. 7



Ref. 30-11

Nr. 8



Ref. 30-12

Nr. 8

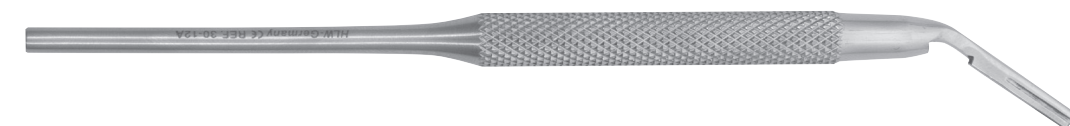

Ref. 30-12A

Nr. 9



Ref. 40-27



Wachsmodellierinstrumente

Wax Modeling Instruments

Laborinstrumente

Laboratory Instruments

Gipsmesser

Plaster Knives

Gipsspatel

Plaster Spatula

Drahtschneider TC

Wire Cutters TC

Mini-LeCron



Ref. 31-1

Zahle



Ref. 31-2

Zahle



Ref. 31-3

Hysin



Ref. 31-4

LeCron



Ref. 31-5

LeCron



Ref. 31-6

LeCron



Ref. 31-7

Zementspatel



Ref. 31-8

Zementspatel



Ref. 31-9

Zementspatel



Ref. 31-10

Zementspatel



Ref. 31-11

Bestell-Nr.
Order-No.

P.K. Thomas 1

Ref. 31-101



P.K. Thomas 2

Ref. 31-102



P.K. Thomas 3

Ref. 31-103



P.K. Thomas 4

Ref. 31-104



P.K. Thomas 5

Ref. 31-105



P.K. Thomas 1

Ref. 31-111



P.K. Thomas 2

Ref. 31-112



P.K. Thomas 3

Ref. 31-113



P.K. Thomas 4

Ref. 31-114



P.K. Thomas 5

Ref. 31-115



Ofenzangen

Muffelzange

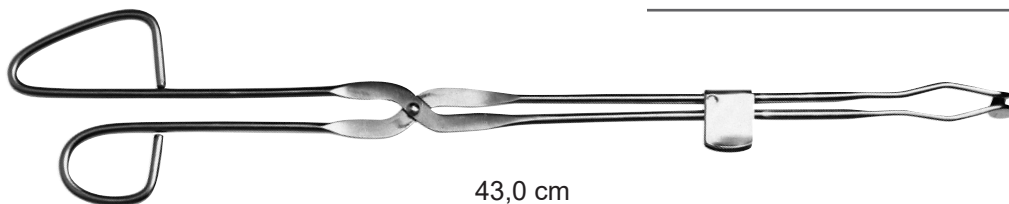

43,0 cm

Ref. 31-53

Muffelzange

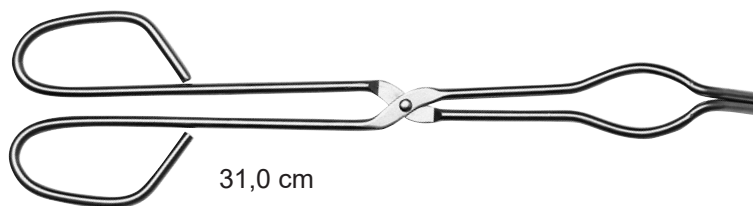

31,0 cm

Ref. 31-52

Muffelzange

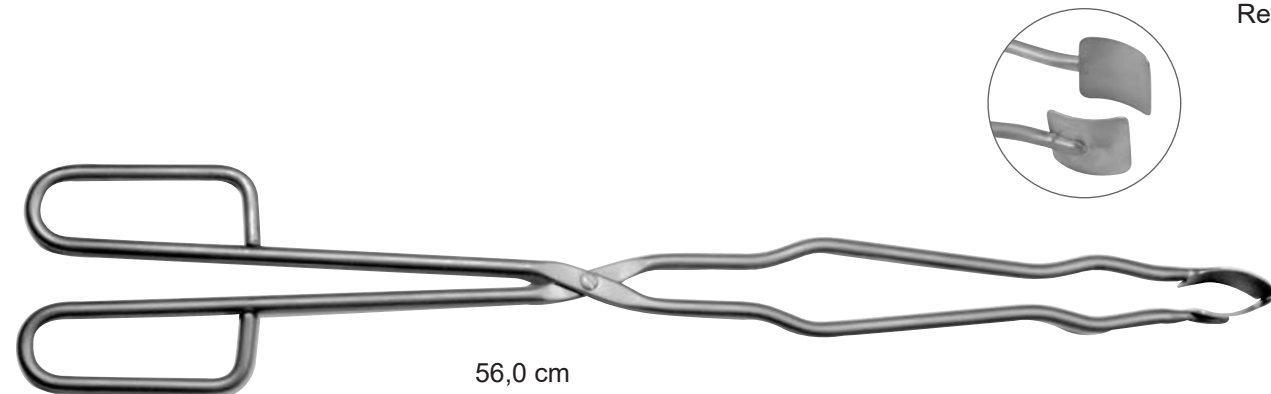

56,0 cm

Ref. 31-54

Halstead / Mosquito

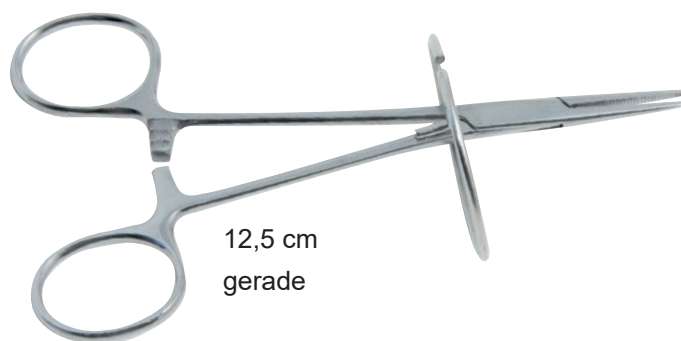

12,5 cm
gerade

Ref. 31-51

Bestell-Nr.
Order-No.

Modellsäge / Saw

Ref. 31-50

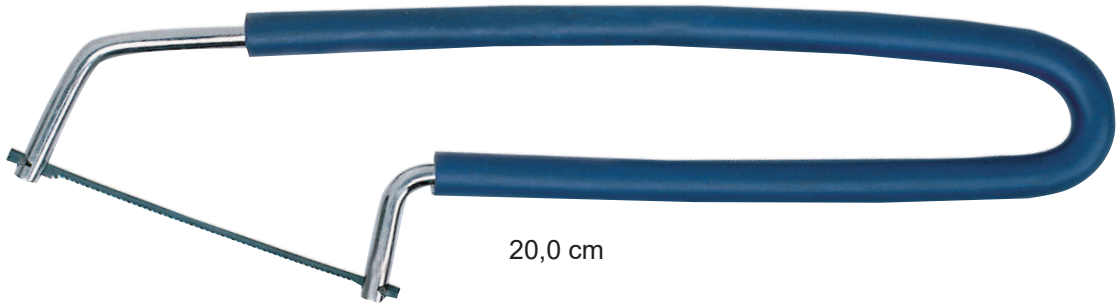

20,0 cm

Zungenbügel

Ref. 15-8



8,0 cm

Ref. 15-7



7,0 cm

Ref. 15-6



6,0 cm

Kronenmesser

Iwanson für Metall

Ref. 31-41



10,5 cm

Iwanson für Wax

Ref. 31-42

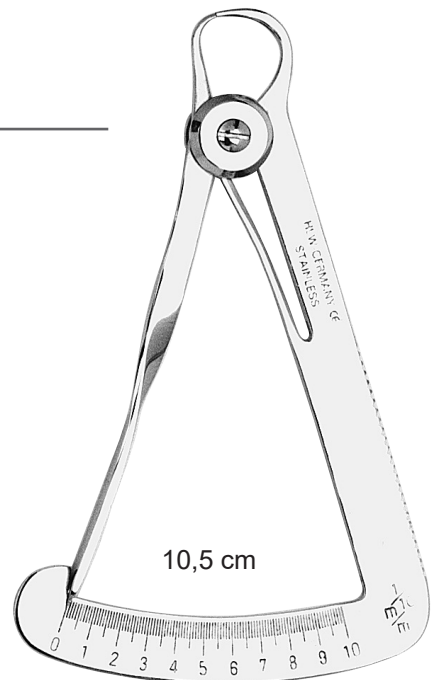

10,5 cm

Lötpinzette gerade - gerieft
Soldering tweezers straight - serrated

Ref. 31-30



17,0 cm

Lötpinzette gebogen - gerieft
Soldering tweezers curved - serrated

Ref. 31-29



16,5 cm

Brenngutträgerpinzette

Ref. 22-40



30,0 cm

Gippschneidezange / Plaster Nipper

Ref. 31-46



21,0 cm

Bestell-Nr.
Order-No.

Antkoviak

Ref. 31-27



13,0 cm

Lessmann

Ref. 31-23



17,0 cm

Fahnenstock

Ref. 31-25



17,0 cm

Lessmann

Ref. 31-24



13,0 cm

Fahnenstock

Ref. 31-26



13,0 cm

Ermert

Ref. 31-22



13,0 cm

Buffalo



14,0 cm

Ref. 31-33

Buffalo



14,0 cm

Ref. 31-34

Gritmann



15,0 cm

Ref. 31-35

Gipsmesser



17,0 cm

Ref. 31-36

Gipsmesser



18,0 cm

Ref. 31-37

Gipsmesser



16,0 cm

Ref. 31-38

Bestell-Nr.
Order-No.

**Gipsspatel
Plasterspatula**

Ref. 31-39



19,0 cm

**Gipsspatel
Plasterspatula**

Ref. 31-40



20,0 cm

**Gipsspatel
Plasterspatula**

Ref. 31-47



21,0 cm

**Anrührspatel gerade
Spatula straight**

Ref. 31-32



18,0 cm

**Anrührspatel gerade
Spatula straight**

Ref. 31-31



20,0 cm

Tungsten Carbide

Mini-Cutter TC

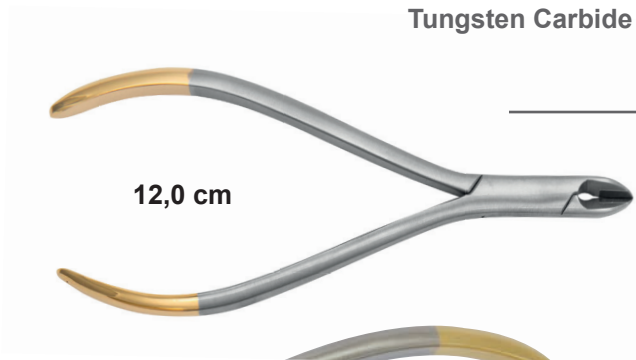

12,0 cm

max. 0,3 - 0,5 mm

Ref. 31-43A

Drahtschneider TC
Wire Cutter TC



13,0 cm

max. 0,5 mm

Ref. 31-43

Drahtschneider TC
Wire Cutter TC



14,0 cm

max. 0,8 mm

Ref. 31-44

Distal-Cutter TC



15,0 cm

max. 0,5 mm

Ref. 31-45B

Drahtschneider TC
Wire Cutter TC

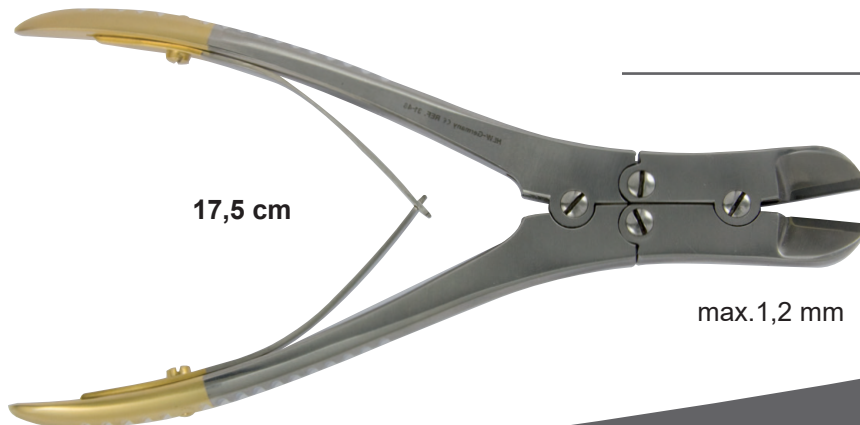

17,5 cm

max. 1,2 mm

Ref. 31-48

Drahtbiegeezangen

Wire Bending Pliers



Flachzangen
Flat Nose Pliers

Teleskopkronenzangen
Telescope Crown Pliers

Flachzangen
Flat Nose Pliers

Bestell-Nr.
Order-No.

14,5 cm

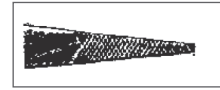

Ref. 32-1

14,5 cm

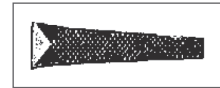

Ref. 32-2

14,5 cm

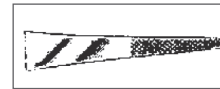

Ref. 32-3

15,0 cm

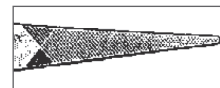

Ref. 32-4

Goslee

14,0 cm

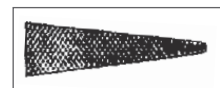

Ref. 32-5

Goslee

14,0 cm



Ref. 32-6

Goslee

13,5 cm

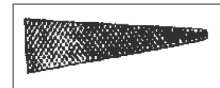

Ref. 32-7

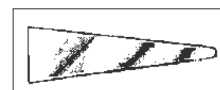

Bestell-Nr.
Order-No.

Nance

Ref. 32-8

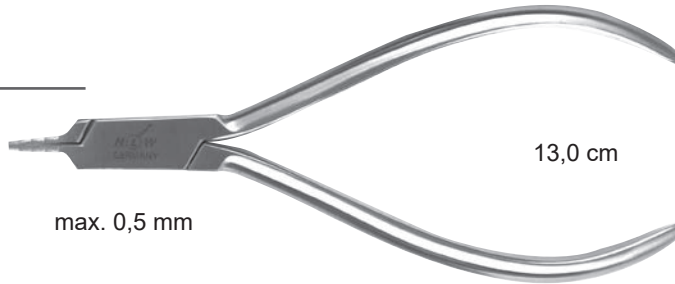
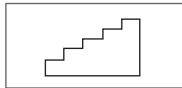

max. 0,5 mm

13,0 cm

Schwarz

Ref. 32-9

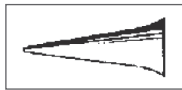

max. 0,7 mm

13,0 cm

Schwarz

Ref. 32-10

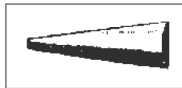

13,0 cm

Schwarz

Ref. 32-11

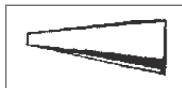

max. 0,8 mm

13,0 cm

Andresen

Ref. 32-12

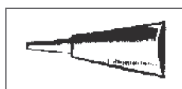

14,0 cm

Schwarz

Ref. 32-13



max. 0,7 - 1,0 mm

14,0 cm

Ref. 32-14



max. 0,7 mm

14,0 cm

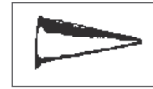

Ref. 32-15



Ref. 32-16

Jarabak

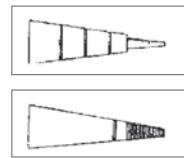

Ref. 32-17

Angle

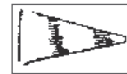
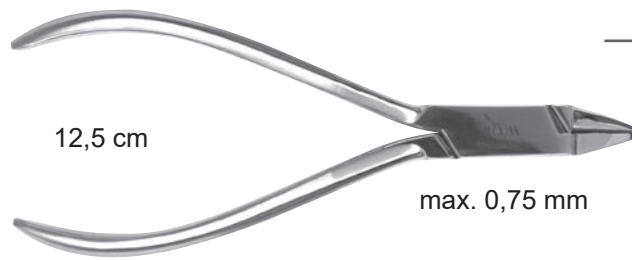

Ref. 32-18

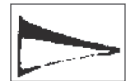

Aderer

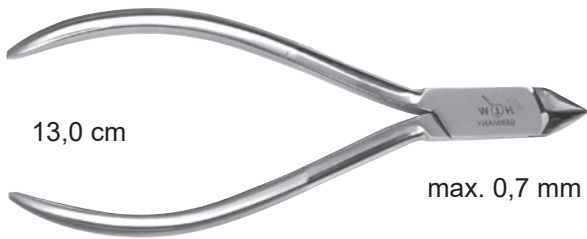

Ref. 32-19



Ref. 32-20

Aderer



Ref. 32-21

Bestell-Nr.
Order-No.

Young

Ref. 32-22

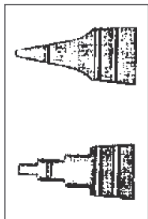

14,0 cm

max. 0,7 mm

Ref. 32-23

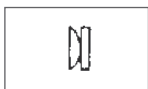

13,0 cm

Frevert

Ref. 32-24

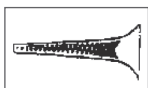

12,0 cm

Adams

Ref. 32-25

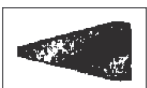

14,5 cm

max. 0,75 mm

Aderer

Ref. 32-26

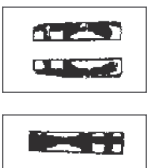

12,5 cm

max. 1,2 mm

Reynold

Ref. 32-27

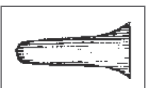

12,5 cm

Angle

Ref. 32-28

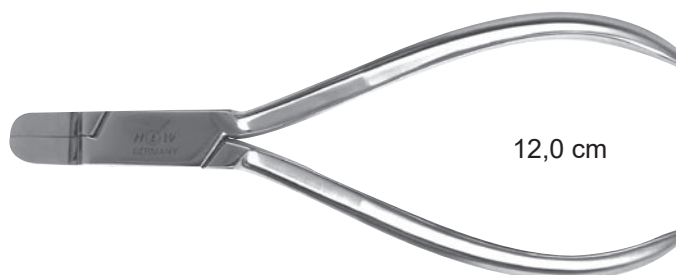

12,0 cm

Schwarz



Ref. 32-30

Nance

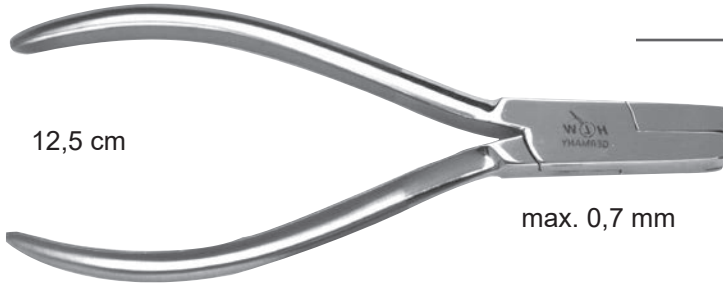

Ref. 32-31



Ref. 32-32

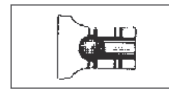

Waldsachs

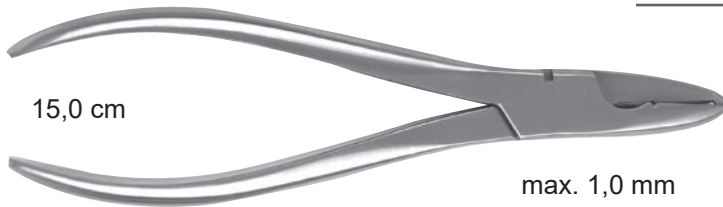

Ref. 32-33

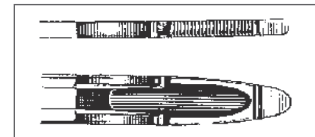

How



Ref. 32-34

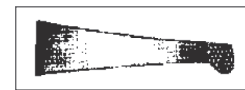

Weingart



Ref. 32-35

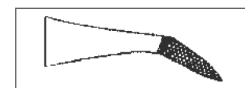

Bestell-Nr.
Order-No.

McKellops

Ref. 32-36



16,0 cm

max. 1,5 mm

McKellops

Ref. 32-37



16,0 cm

max. 1,5 mm

Kupferringentferner Copper Ring Remover

Ref. 32-40

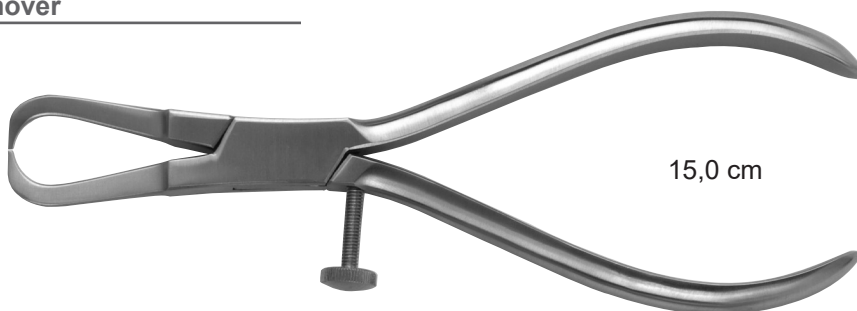

15,0 cm

Teleskopkronenzange Telescope Crown Plier

Ref. 32-41

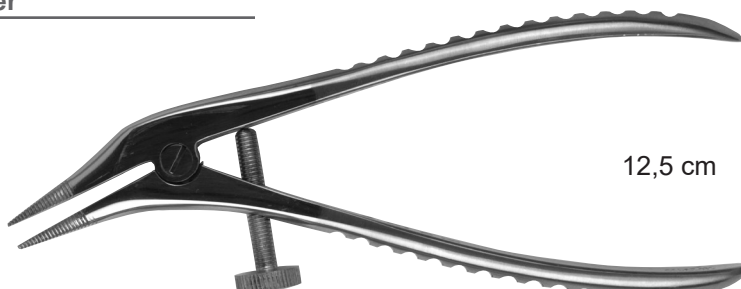

12,5 cm

Kramponzangen mit feiner Spitze

Ref. 32-38A



16,0 cm

Bending max. 0,9 mm
cutting max. 0,7 mm

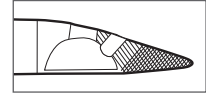

Kramponzangen mit feiner Spitze

Ref. 32-39A

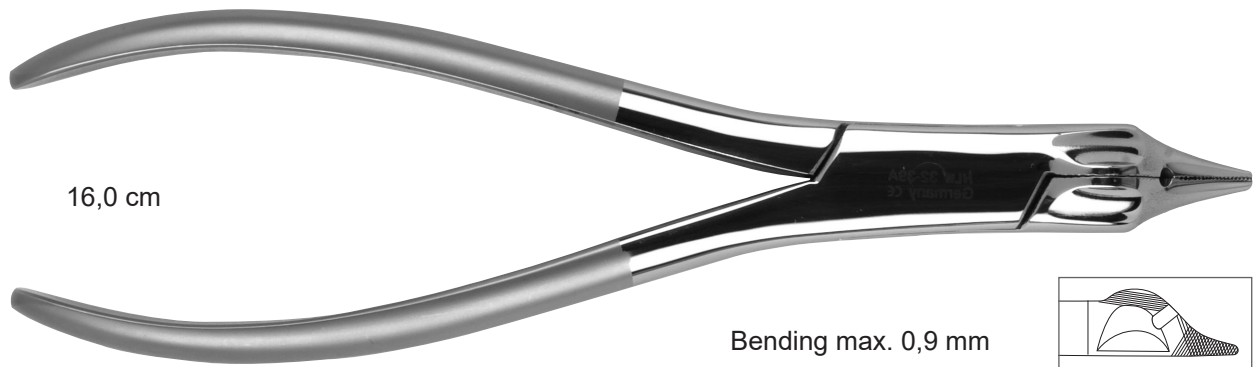

16,0 cm

Bending max. 0,9 mm
cutting max. 0,7 mm

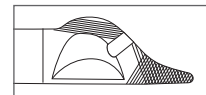

Mini-Kramponzangen mit feiner Spitze

Ref. 32-39B

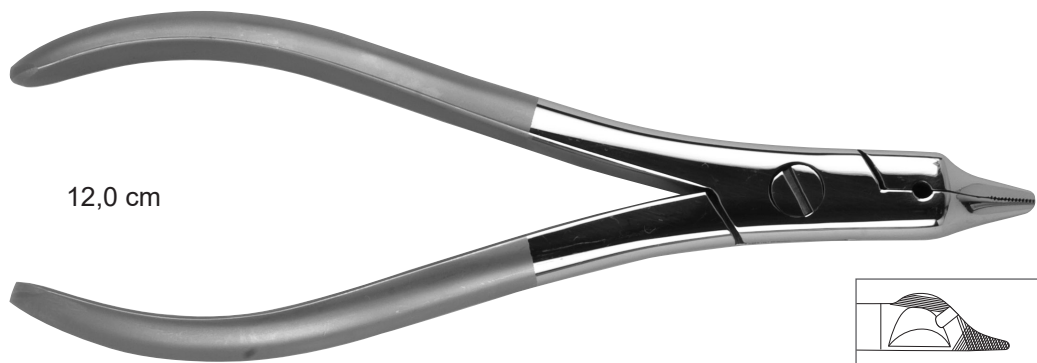

12,0 cm

Bending max. 0,9 mm
cutting max. 0,7 mm

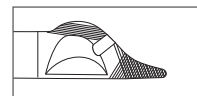

Bestell-Nr.
Order-No.

Ref. 32-45



- verhindert die Verletzungsgefahr und schont Hände und Finger
- temperaturbeständig bis 150° C
- umfassende Bearbeitung aller Flächen und Ränder von Kronen und Inlays

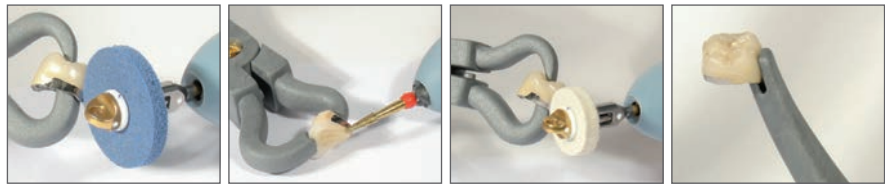

Spreitzpinzette mit Dehnschraube

Ref. 32-44 gebogen



Kera-Grip II (gebogen)

Ref. 32-47

- Haltezange für Keramikronen
- inklusive Diamanteinsätze

Ref. 32-47A



Diamanteinsätze
1 Paar



Teleskopkronenzange FG

Ref. 32-43 Größe 11,6 cm, auswechselbare Spitzen für Diamanten mit FG Schaft (Lieferung mit Einsätzen)

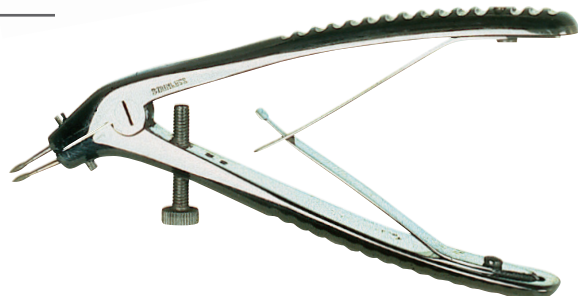

Teleskopkronenzange diamantiert

Ref. 32-42 Körnung D 107
12,0 cm





Abdrucklöffel Impression Trays



Abdrucklöffel solide
Impression Trays solid

Abdrucklöffel perforiert
Impression Trays perforated

Laborinstrumente
Laboratory Instruments

Bestell-Nr.
Order-No.

Oberkiefer Upper

Unterkiefer Lower



XL Ref. 33-06



XL Ref. 33-01



L Ref. 33-07



L Ref. 33-02



M Ref. 33-08



M Ref. 33-03



S Ref. 33-09



S Ref. 33-04



XS Ref. 33-10



XS Ref. 33-05



XXS Ref. 33-30



XXS Ref. 33-25

Oberkiefer Upper

Unterkiefer Lower



XL Ref. 33-16



XL Ref. 33-11



L Ref. 33-17



L Ref. 33-12



M Ref. 33-18



M Ref. 33-13



S Ref. 33-19



S Ref. 33-14



XS Ref. 33-20



XS Ref. 33-15



XXS Ref. 33-40



XXS Ref. 33-35

Bestell-Nr.
Order-No.

Ref. 33-57 OK „solide“
Ref. 33-58 UK



Ref. 33-59 OK „perforiert“
Ref. 33-60 UK

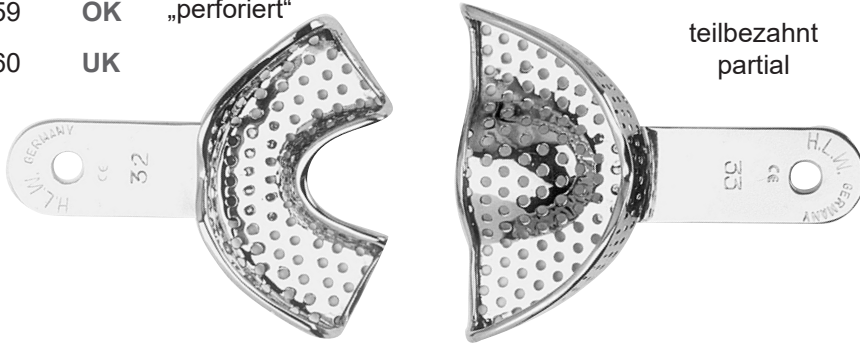

Ref. 33-61R
Ref. 33-61L

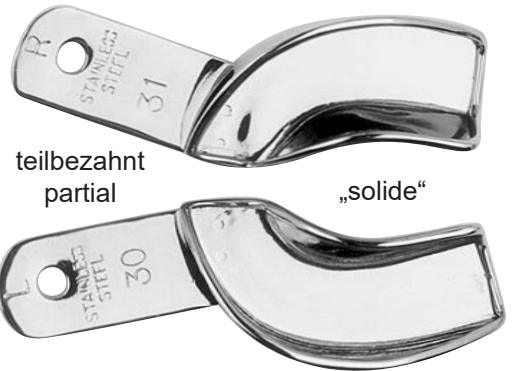

Ref. 33-62R
Ref. 33-62L

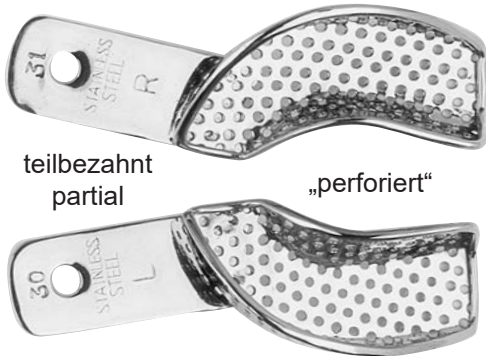

Ref. 33-63



Ref. 33-64

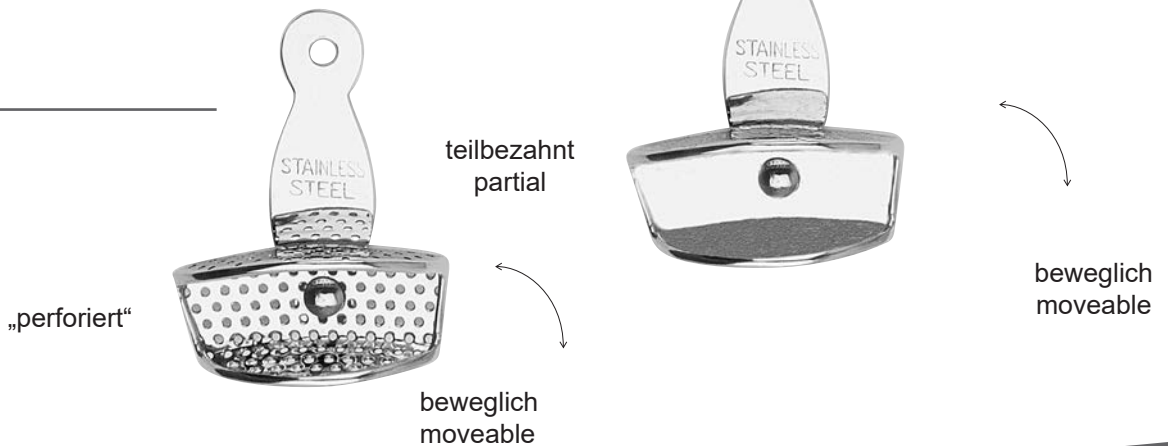

unbezahnter Kiefer toothless
§ olide“

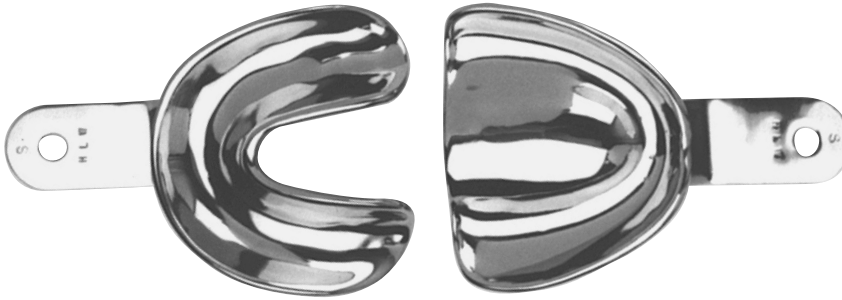

Größe/Size	Ref-No.
UK-1 XL	33-41
UK-2 L	33-42
UK-3 M	33-43
UK-4 S	33-44

Größe/Size	Ref-No.
OK-1 XL	33-45
OK-2 L	33-46
OK-3 M	33-47
OK-4 S	33-48

unbezahnter Kiefer toothless
p erforiert“

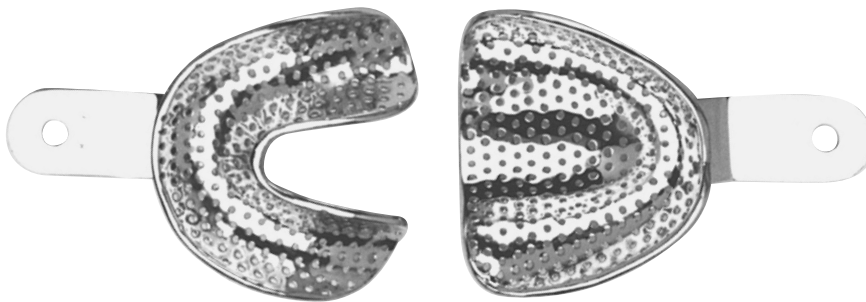

Größe/Size	Ref-No.
UK-1 XL	33-49
UK-2 L	33-50
UK-3 M	33-51
UK-4 S	33-52

Größe/Size	Ref-No.
OK-1 XL	33-53
OK-2 L	33-54
OK-3 M	33-55
OK-4 S	33-56

Codierringe für Abdrucklöffel



Packung sortiert 24 Stück
6 Farben (rot, grün, blau, gelb, violett, weiss)

Ref. 33-001



Bestell-Nr.
Order-No.

Oberkiefer Upper

Unterkiefer Lower



Größe 4
Ref. 34-01



Größe 4
Ref. 34-06



Größe 3
Ref. 34-02



Größe 3
Ref. 34-07



Größe 2
Ref. 34-03



Größe 2
Ref. 34-08



Größe 1
Ref. 34-04

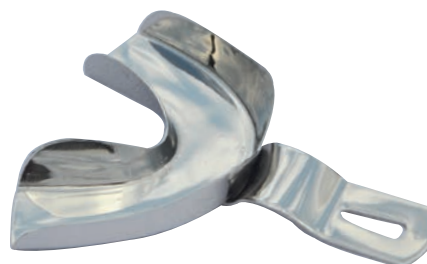

Größe 1
Ref. 34-09



Größe 0
Ref. 34-05

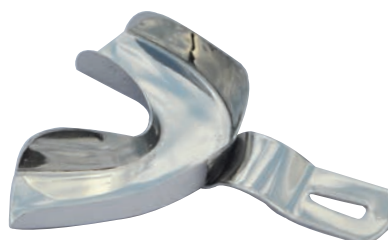

Größe 0
Ref. 34-10

Abdruckklöfel nach "Fricke" perforiert

Bestell-Nr.
Order-No.

Oberkiefer Upper

Unterkiefer Lower



Größe 4
Ref. 34-11



Größe 4
Ref. 34-16



Größe 3
Ref. 34-12



Größe 3
Ref. 34-17



Größe 2
Ref. 34-13



Größe 2
Ref. 34-18



Größe 1
Ref. 34-14



Größe 1
Ref. 34-19



Größe 0
Ref. 34-15



Größe 0
Ref. 34-20

Bestell-Nr.
Order-No.

Oberkiefer Upper

Unterkiefer Lower



XL Ref. 34-21



XL Ref. 34-26



L Ref. 34-22

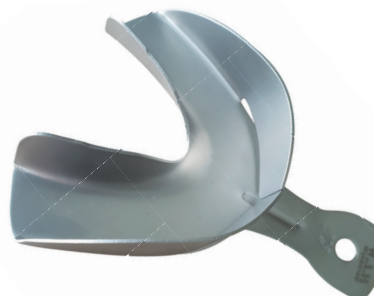

L Ref. 34-27



M Ref. 34-23

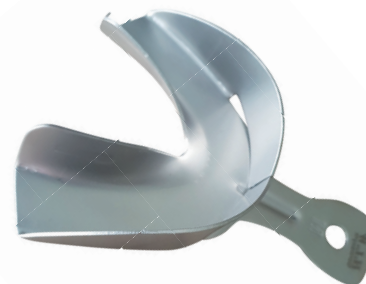

M Ref. 34-28



S Ref. 34-24



S Ref. 34-29

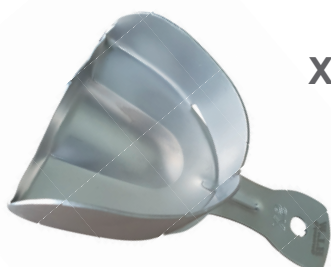

XS Ref. 34-25



XS Ref. 34-30

Abdruckklöfel perforiert
Impression Trays perforated

Bestell-Nr.
Order-No.

Oberkiefer Upper

Unterkiefer Lower



XL Ref. 34-31



XL Ref. 34-36



L Ref. 34-32



L Ref. 34-37



M Ref. 34-33



M Ref. 34-38



S Ref. 34-34



S Ref. 34-39



XS Ref. 34-35



XS Ref. 34-40

Hersteller

Anwendungsbereich

Wiederverwendbare zahnärztliche Handinstrumente

Ausnahmen:

- ▶ Aluminiumlegierungen, die an ihrer leuchtend farbigen Beschichtung auf den Metallteilen erkennbar sind
 - ▶ Aluminiumhaltige Instrumente können von alkalischen Reinigungsmitteln und Lösungen mit einem PH-Wert > 7 beschädigt werden.
 - ▶ Instrumente mit verchromten Teilen wie z.B. Zylinderampullenspritzen Ringgriff, auswechselbare Ampullenhalter, Salbenkanülen, Mundspiegel, Resektionsspiegel, Amalgampistolen, Metallspitzen für Amalgampistolen, Podologiezange 1756, Mundspiegelgriff 485 CH, Technikzangen, Serviettenkettchen
 - ▶ nicht geeignet für Thermodesinfektion und Ultraschallbad – auf geeignete Desinfektionsmittel achten
-
- | | | |
|----------|--|---|
| 1 | Warn- und Sicherheitshinweise | <ul style="list-style-type: none"> ▶ Eine mangelhafte Pflege und Aufbereitung, eine unsachgemäße Handhabung, eine Zweckentfremdung und Veränderungen am Instrument können seine Gebrauchsfähigkeit erheblich beeinträchtigen, Schäden herbeiführen und Grund für ernsthafte Verletzungen von Patient und Anwender sein. ▶ Wiederverwendbare Instrumente werden nicht steril geliefert. Sie müssen daher vor der ersten Anwendung gereinigt und sterilisiert werden. ▶ Bei der Reinigung von langen, engen Kanülen, von Sacklöchern und Gelenken (Scharnieren), Rasten, Sperren, Schließern ist besondere Aufmerksamkeit erforderlich – sie erfordern ggf. gesonderte Reinigungsmaßnahmen. ▶ Zum Umgang mit kontaminierten Instrumenten gehören Handschuhe und Augenschutz. ▶ Hinweise und Gebrauchsanleitung der Hersteller der benutzten Geräte und Mittel unbedingt beachten (z.B. Konzentrationen, Einwirkzeiten, Zyklen etc.) |
| 2 | Wiederaufbereitung und Lebensdauer von Instrumenten | <ul style="list-style-type: none"> ▶ Die Häufigkeit der Wiederaufbereitung hat nur geringe Auswirkungen auf diese Instrumente. ▶ Die Lebensdauer der Instrumente wird normalerweise vom Verschleiß und etwaigen Beschädigungen im Gebrauch begrenzt. |
| 3 | Maßnahmen am Ort des Gebrauchs

Aufbewahrung und Transport | <ul style="list-style-type: none"> ▶ d des Instrument ist vor Gebrauch einer Sichtprüfung und Funktionskontrolle zu unterziehen bzw. – wenn zerlegt – wieder zusammensetzen. Prüfkriterien sind Beschädigungen wie Risse, Löcher, Kratzer, Verbiegungen, Schwergängigkeit von Gelenken, stumpfe und scharfge Schneidkanten, nicht mehr einwandfrei funktionierende Sperren, Rasten, Schließern etc. ▶ empfindliche und feine Instrumente vor Beschädigungen schützen ▶ sofort nach der Benutzung Rückstände an Blut, Gewebe und Arzneimitteln von den Instrumenten mit dafür geeigneten Methoden entfernen ▶ Instrumente sollten grundsätzlich trocken, staubfrei und nicht in der Nähe von Chemikalien gelagert werden. Ein Transport kann auch in feuchtem Zustand erfolgen – keinesfalls aber in NaCl-Lösungen (Gefahr von Korrosion durch Lochfraß und Spannungsrisse). ▶ Die Wiederaufbereitung sollte baldmöglichst nach der Verwendung des Instruments erfolgen, da angetrocknete Verschmutzungen die Reinigung erschweren. Kontaminierte und feuchte Instrumente sind anfälliger für Rost und Korrosion. ▶ Instrumentensiebe und Waschtrays nicht überfüllen |
| 4 | Reinigungsvorbereitung | <ul style="list-style-type: none"> ▶ Bei einer verzögerter, späterer Wiederaufbereitung müssen Instrumente vor Bestückung des Waschautomaten manuell vorgereinigt werden (siehe nächste Ziffer 5). ▶ Ein Zerlegen von Instrumenten ist nur dort erforderlich, wo dies von der Gebrauchsinformation für das jeweilige Instrument gefordert wird. ▶ Gelenkinstrumente (z.B. Zangen, Scheren etc.) stets in geöffnetem Zustand aufbereiten |
| 5 | Reinigung - manuell | <ul style="list-style-type: none"> ▶ nur vom jeweiligen Hersteller für die Verwendung an Dentalinstrumenten zugelassene Reinigungslösung ohne proteinfixierende Wirkung verwenden – vorgeschriebenes Konzentration und Einwirkzeit beachten ▶ verschmutzte Oberflächen unter fließendem Wasser abspülen ▶ Reinigungsmittel mit Bürste auf alle Oberflächen auftragen – Gelenkinstrumente in beiden Positionen (offen – geschlossen) ▶ Auftrag von Reinigungslösung bei Kanülen und Sacklöchern mit dafür geeigneten Bürsten ▶ Instrument anschließend ausreichend lange unter fließendem Wasser abspülen – dabei muß das Wasser auch die Kanülen durchfließen und Sacklöcher wiederholt gefüllt und geleert werden |

- 6** Reinigung im Automaten
- ▶ nur vom jeweiligen Hersteller zur Verwendung für Dentalinstrumente zugelassene Wasch- oder kombinierte Wasch- und Desinfektionsgeräte verwenden
 - ▶ nur vom jeweiligen Hersteller sowohl für die Verwendung an Dentalinstrumenten wie im benutzten Reinigungsgerät bestimmte Reinigungsmittel verwenden
 - ▶ Gebrauchsanweisung der Geräte- und Chemikalienhersteller beachten
 - ▶ Instrumente immer mit geöffnetem Gelenk und so einlegen, daß Flüssigkeit aus Kanülen und Sacklöchern abfließen kann
- 7** Inspektion nach der Reinigung
- ▶ Sichtprüfung aller Instrumente auf verbliebene Verschmutzungen – Reinigungszyklus ggf. wiederholen
 - ▶ dabei Kanülen, Hohlräume, Sacklöcher und Gelenke besonders beachten, ggf. auch gesonderter Reinigung unterziehen
- 8** Desinfektion
- ▶ ph-neutrale oder alkalische Reinigungsmittel verwenden
 - ▶ Desinfektionslösungen in Übereinstimmung mit den Herstellerangaben (Etikett) verwenden
 - ▶ Bei der automatischen Reinigung kann abschließend eine Thermodesinfektion erfolgen (Herstellerangaben für den Thermodesinfektor beachten)
 - ▶ Für die Schlußspülung nur vollentsalztes Wasser verwenden (VE-Wasser)
- 9** Trocknung
- Wenn die Trocknung Teil des Reinigungs-/Desinfektionszyklus ist, sollten 93 °C nicht überschritten werden.
- 10** Instandhaltung
Wartung
- Hochwertiges Silikonspray oder Chirurgie-Schmieröl auf die Gelenke auftragen.
- 11** Kontrolle Funktionsprüfung
- ▶ Instrumente auf Risse und Beschädigungen überprüfen, stumpfe oder beschädigte Instrumente aussortieren
 - ▶ Funktionsfähigkeit kontrollieren
 - ▶ Gelenkinstrumente auf Leichtgängigkeit überprüfen (zu großes Spiel vermeiden)
 - ▶ Sperrmechanismen (z.B. Sperr-Rad, Raste) auf Funktion überprüfen
 - ▶ Alle Instrumente:
Sichtprüfung auf Risse, Löcher, Beschädigung der Oberflächen und Arbeitsenden sowie Verschleiß durchführen, Schneidekanten gleichmäßig, scharf und frei von Scharten
 - ▶ Instrumente als Bestandteil komplexerer Systeme:
Funktionskontrolle im Systemzusammenhang (ggf. Zusammenbau-, Schnitt- und Anschlußstellen)
- 12** Verpackung zu Sterilisation
- ▶ Einzelinstrument:
genormte Verpackungsmaterialien verwenden (Beutel so groß, daß die Versiegelung nicht unter Spannung steht)
 - ▶ bei Sets:
Instrumente in dafür vorgesehene Trays einsortieren oder auf Allzweck-Sterilisationstrays legen (Schneiden und Spitzen geschützt einordnen)
 - ▶ Trays mit einem für diese geeigneten Verfahren verpacken
- 13** Sterilisation
- ▶ im Autoklaven oder Heißluftsterilisator nach Vorgaben der Hersteller
 - ▶ Angaben der Gerätehersteller unbedingt beachten
 - ▶ Bei der gleichzeitigen Sterilisation mehrerer, auch verschiedener Instrumente auf die Maximalbelastung des Sterilisators und etwaige Hinweise zu Unverträglichkeiten beachten – siehe Gebrauchsanweisung des Geräteherstellers
- 14** Lagerung
- ▶ Instrumente zur Vermeidung von Kondensationsbildung trocken, staubfrei und nicht in der Nähe von Chemikalien lagern
 - ▶ Instrumente zur Vermeidung erneuter Kontamination bis zur Wiederverwendung in den für die Sterilisation benutzten Verpackungen lagern
 - ▶ Behälter und Verpackungen vor dem Öffnen abtrocknen lassen, um erneute Kontamination mit Feuchtigkeit zu vermeiden

VORBEMERKUNG: rostfrei, nicht rostend oder korrosionsbeständig?

Die meisten zahnärztlichen Instrumente werden aus korrosionsbeständigem Stahl gefertigt.

Der richtige Begriff ist hier „korrosionsbeständiger Stahl“, nicht das im Volksmund gebräuchliche „rostfrei“.

Die Beständigkeit der Edelstähle gegen Korrosion beruht nämlich darauf, daß sich durch Legierung und Herstellverfahren an den Oberflächen sogenannte Passivschichten ausbilden, die den Stahl vor den vielfältigsten Angriffen mechanischer, thermischer oder chemischer Art schützen sollen.

Werden diese Schutzschichten durch äußere Einflüsse zerstört, kann jeder Instrumentenstahl korrodieren. Um Korrosionsschäden zu vermeiden, kommt es deshalb darauf an, die Schutzschichten durch sachkundige Aufbereitung nicht zu gefährden und so die Korrosionsbeständigkeit zu erhalten.

Feststellung	Ursache(n)	Abhilfe – Empfehlungen
Flecken	<p>Finden sich am Instrument nach der Reinigung Flecken, sind diese in den seltensten Fällen Anzeichen für Korrosion und schon gar kein Rost – selbst wenn die Flecken bräunlich oder rötlich schimmern.</p> <p>Ursache für die Fleckenbildung ist zumeist die Ablagerung von Mineralien aus dem Leitungswasser. Sie ergeben sich meist bei hohen Temperaturen wie im Thermodesinfektor (93 °C).</p>	<p>Aus demineralisiertem, d.h. voll entsalztem Wasser (VE-Wasser) können sich keine Mineralien ablagern.</p> <p>Zur Entfernung aller Rückstände sollte nach der Thermodesinfektion am Ende ein Spülgang mit Säure stehen.</p> <p>Bei der Programmwahl achte man darauf, daß die erforderliche hohe Temperatur erst gegen Ende des Programms erreicht wird.</p>
Verfärbungen	<p>Auch Verfärbungen sind in der Regel keine Korrosion. Sie werden durch Spuren von Wasserinhaltsstoffen hervorgerufen wie z.B. Silikate/Kieselsäure, Eisen-, Kupfer- und Manganverbindungen.</p>	<p>Instrumente mit geeigneten, säurehaltigen Reinigungsmitteln abreiben bzw. einlegen (Herstellangaben beachten). Saurer Zemententferner ist keinesfalls geeignet, er führt zu bleibenden Schäden am Instrument.</p>
Anlauffarben	<p>Irisierende Verfärbungen ohne klare Konturen entstehen durch Schwermetallverbindungen und Silikate im Wasser.</p>	<p>Verwendung von VE-Wasser zur Schlußspülung und zur Erzeugung von Reindampf.</p>
Schwarzfärbung	<p>Versilberte Instrumente und solche aus nicht rostendem Chromstahl können schwarz anlaufen. Dies beeinträchtigt weder hygienische Sicherheit noch Eigenschaften oder Lebensdauer.</p> <p>Ausnahme: Ursache war ein Säureangriff, die Oberfläche wurde angebeizt.</p>	<p>Keine Maßnahmen erforderlich.</p> <p>Ausnahme: Angebeizte Instrumente aussortieren, da mit weiterer Korrosion zu rechnen ist.</p>
Flugrost	<p>Diese Beeinträchtigung der Instrumentenoberflächen entsteht oft dann, wenn einwandfreie Instrumente gemeinsam mit bereits korrodierten Instrumenten gereinigt und dann sterilisiert werden.</p> <p>Eine weitere, durchaus häufige Ursache liegt in der Kontamination durch den Autoklaven selbst.</p>	<p>Flugrost kann im Anfangsstadium meist noch durch Abwischen entfernt werden – am besten gleich nach der Entdeckung.</p> <p>Bereits korrodierte Instrumente, von denen sich Rostanflug nicht mehr abwischen läßt, müssen vor der Reinigung und einer Sterilisation vom Rost befreit werden.</p> <p>Ist das nicht möglich, muß das Instrument entsorgt werden.</p> <p>Auf keinen Fall Instrumente mit Korrosionserscheinungen gemeinsam mit einwandfreien reinigen und sterilisieren!</p>

Korrosion – Lochfraß

Werden Instrumente nach dem Gebrauch und dem Desinfektionsbad nicht gründlich mit klarem Wasser abgespült, können Reste von Blut und Chemikalien auf dem Metall bleiben, die dann bei der Thermodesinfektion und Sterilisation eingebacken werden und einer Korrosion damit Tür und Tor öffnen.

Korrodiert das Metall in der Folge weiter in die Tiefe (Lochfraß), kann das Instrument an dieser Stelle schon bei geringer Belastung brechen.

Ähnliche Auswirkung haben mineralische Ablagerungen aus dem Leitungswasser oder die Rostanlagerung von bereits korrodierten Instrumenten.

Korrosion und Lochfraß kann nur vorgebeugt werden:

- ▶ durch gründliche Entfernung von Blut, Chemikalien und anderen Rückständen vom Instrument nach dessen Gebrauch
- ▶ durch Verwendung von VE-Wasser, d.h. voll entsaltem bzw. demineralisiertem Wasser im Thermodesinfektor wie bei der Sterilisation (Autoklav)

Kofferdam-Klammern

Neben den oben bei „Korrosion – Lochfraß“ genannten Ursachen werden Klammern von den bei der Wurzelbehandlung häufig verwendeten Chemikalien wie Natriumhypochlorid angegriffen. Sie wirken auf Metallflächen äußerst aggressiv!

Die daraus entstehende Korrosion läßt die unter Spannung stehenden Klammern bei geringer Beanspruchung brechen.

Mehr noch als bei anderen Instrumenten müssen Kofferdam-Klammern sofort nach der Anwendung unter fließendem Wasser gründlichst von anhaftenden Chemikalien gereinigt werden.

Edelstahl und Amalgam

Da es sich beim Amalgam um das chemisch „edlere“ Metall handelt, kann es auf Edelstahlinstrumenten zu Korrosion führen.

Anhaftungen von Amalgam sofort nach der Behandlung von den Instrumenten vollständig entfernen.

Abrieb – Korrosion an Scharnieren und Gelenken

Reiben Flächen aus Edelstahl aufeinander, wie das bei Zangen und Scheren der Fall ist, kann möglicherweise nicht rostfreier Abrieb entstehen.

Wird das nicht verhindert oder der entstandene und oft kaum sichtbare Abrieb nicht entfernt, führt die so entstehende und sich ausbreitende Korrosion zu Schwergängigkeit und ggf. zum Bruch der Gelenke und Scharniere.

Instrumente, bei denen die Bewegung ihrer Teile zueinander Abrieb entstehen läßt, prinzipiell in geöffnetem Zustand reinigen, sterilisieren und lagern.

Pflegemittel wie Silikonspray verringern den Abrieb gegenüber trockenen Flächen erheblich, erhalten so die Gängigkeit des Gelenks und verlängern die Lebensdauer des Instruments deutlich.

Erstmaßnahme bei Korrosion

Trotz aller Vorsichts- und Pflegemaßnahmen läßt sich am Instrument irgendwann doch einmal Korrosion feststellen.

Verantwortlich dafür ist in der Regel eine oder mehrere der vorstehenden Ursachen.

Sofortmaßnahme:

- ▶ Wenn Korrosion sichtbar wird, muß sofort versucht werden, sie durch kräftiges Reiben mit einem Tuch oder einem Radiergummi zu entfernen.

Korrosion läßt sich nicht entfernen

Risse, Lochfraß und andere eindeutige Beschädigungen der Oberflächen

Die jeweilige Ursache(n) hat bzw. haben zu Korrosiven Schäden geführt, die durch schonende Maßnahmen wie Abreiben nicht mehr zu beseitigen ist.

Nicht mehr zu beseitigende Korrosionsschäden an Instrumenten beeinträchtigen die Funktion und damit die Benutzbarkeit, sie gefährden die Erhaltung der hygienischen Sicherheit und können das andere Instrumentarium mit Flugrost kontaminieren.

Sofortmaßnahme:

- ▶ Instrument(e) aussortieren und entsorgen.

Sehr geehrter Kunde,
nachfolgend möchten wir Ihnen erläutern, warum ein rostfreies Edelstahlinstrument Flecken, Verfärbungen oder sogar Rost ansetzen kann. Es gibt einige Grundvoraussetzungen für den Umgang sowie für die Pflege der Instrumente, welche die Lebensdauer verlängern.

Beachten Sie bitte folgendes:

- 1 Bei einem neu erworbenen Instrument ist vor dem Sterilisieren darauf zu achten, daß es besonders gründlich gereinigt wird. Bei der Handreinigung empfiehlt sich ein spezieller Instrumentenreiniger und eine weiche Bürste (keine Metallbürste). Als gründliche und wirkungsvolle Reinigungsart gilt das Ultraschallreinigungsggerät (Ultraschallreinigungsmittel verwenden). Besonders wichtig ist dabei, daß Instrumente wie Zangen jeder Art, Nadelhalter und Scheren im geöffneten Zustand in die Reinigungslösung eingelegt werden (Reinigungsdauer ca. 10 Minuten).
- 2 Das Instrumentarium sollte nach jeder Reinigung unverzüglich und gründlich mit heißem Wasser gespült werden. Aber auch nach jedem Gebrauch, wenn es mit Verunreinigungen irgendwelcher Art (z. B. Blut, Serum, Salzlösungen usw.) in Berührung kam.
- 3 Achten Sie darauf, daß das Instrument vollständig trocken ist (dies gilt besonders für die Zwischenräume), bevor Sie es in eine sterile Verpackung geben oder anderweitig einlagern. Verbleibende Restfeuchtigkeit kann Korrosion oder Fleckenbildung verursachen.
- 4 Falls Sie das Kaltsterilisationsverfahren anwenden, sollten Sie die Instrumente nicht längere Zeit in der Desinfektionslösung belassen; es könnte sich ansonsten Korrosion bilden. Spülen Sie deshalb nach der Kaltsterilisation das Instrument in destilliertem Wasser und trocknen Sie es anschließend gründlich.
- 5 Verwenden Sie keine ätzenden oder sonstigen Reinigungsmittel, sondern nur Spezialreiniger für chirurgische Instrumente.
- 6 Überprüfen Sie das in Ihrem Autoklaven befindliche Wasser auf folgende Verunreinigungen: Eisen, Natrium, Calcium, Magnesium und Kupfer. Diese Elemente verursachen Flecken, Verfärbungen sowie Korrosionsansätze auf den Instrumenten. In Regionen mit sog. „hartem Wasser“ müssen die Dampfleitungen in bestimmten Zeitabständen gereinigt werden. (Diese Maßnahme ist entbehrlich, wenn Sie destilliertes Wasser für Ihren Autoklaven verwenden.) Installieren Sie gegebenenfalls einen Dampffilter, der Leitungsablagerungen verhindert.
- 7 Vergewissern Sie sich, daß die Musselintücher ausreichenden Spülgängen in der Wäscherei unterzogen worden sind (min. 6 - 8 Minuten) Rückstände von Chloriden und Bleichsubstanzen können Flecken bzw. korrosive Rückstände während der Autoklavierung verursachen.
- 8 Beachten Sie bitte, daß sich Ihre Instrumente nicht länger als notwendig in folgenden Lösungen befinden (es besteht ansonsten die Gefahr von Rost- bzw. Korrosionsbildung):
Aluminium, Barium, Calcium, Eisen oder Stannichloridlösung
Phenol, Lysol, Iodine
Säuren, Quecksilber oder Kaliumlösungen
- 9 Sterilisieren Sie rostfreie Edelstahlinstrumente nicht gleichzeitig mit verchromten Instrumenten. Auf der Oberfläche der Chromplattierung entstehen elektrolytische Verbindungen zwischen den unterschiedlichen Materialien bzw. Legierungen. Eine Verfärbung oder Rostentwicklung kann sich als Auswirkung ergeben.
- 10 Erwärmen Sie - falls möglich - die Instrumente im Autoklaven etwas, bevor Sie Dampf passieren lassen. Sie verhindern dadurch übermäßige Kondensation auf der Oberfläche des Instruments.
- 11 Öffnen Sie den Autoklaven nicht so schnell nach dem Sterilisationszyklus, da sonst eine übermäßige Kondensation auf der Oberfläche des Instruments entsteht. (Lassen Sie das Sterilisationsgut etwas abtrocknen, bevor Sie den Autoklaven öffnen.)

Wenn Sie alle oben aufgeführten Pflegehinweise befolgen und nur Instrumentenreiniger sowie spezielle Instrumentenöle für die Pflege verwenden, sorgen Sie gleichzeitig für eine lange Lebensdauer Ihres Instruments.

To Our Customers:

Concerning your question on why standing, pitting or rusting can develop in stainless steel instruments; there are some basic points for the care and handling of surgical instruments which will extend the life of the instrument, eliminate staining or corrosion and lower the cost in use.

These are as follow:

- 1 After receiving of new instrument you should clean it exactly before sterilizing process. If you prefer manual cleaning, please take soft brush (never metal brush) and special instrument cleaner. Do you dispose of Ultrasonic cleaner, then you have the most and best effective way to clean surgical instruments (take special ultrasonic cleaner).
- 2 The Instruments should be rinsed as soon as possible after cleaning process and also after using to remove blood, serum and saline. Do not use a sponge basin as any residue from normal saline solution can cause corrosion to develop over a period of time. The rinsing of instruments should be with distilled water.
- 3 Instruments should be thoroughly dried after cleaning and before wrapping or storing, as moisture left in the box lock or serrations can cause rust or corrosion to develop.
- 4 Do not leave instruments in a cold sterilisation soak solution for extended periods as these solutions tend to be corrosive (after cold sterilization, rinse the instruments in distilled or demineralized water and dry thoroughly).
- 5 If using cold sterilisation technique, change the solution according to directions as prolonged use will cause the solution to become corrosive.
- 6 Do not use caustic cleaners or any other cleaner except those specified for cleaning surgical instruments.
- 7 Check your autoclave: Iron, sodium, calcium, magnesium or copper in your water can cause spotting, staining or corrosion to occur. In hard water areas, clean the line deposits from steam lines periodically or use distilled or demineralized water for your autoclave. Install a steam filter if possible. It will remove most of dirt, rust and pipe scale.
- 8 Make sure your muslim wraps are rinsed sufficiently (6 to 8 minutes) by the laundry to remove all chlorine bleach as any residue can cause staining or corrosion during autoclaving.
- 9 Do not leave instruments in the following solutions for extended periods as corrosion can result:
- Aluminium, Barium, Calcium, Ferrous or Strannous Chloride solutions.
- Phenol, Lysol or Iodine.
- Dakin's Solution or Zephirin.
- Any acid, Mercury or Potassium solution.
- 10 Do not sterilize stainless steel instruments with chrome plated instruments if possible, as any break in the surface of the chrome plate will allow an electrolytic action to develop between the dissimilar metals, causing pitting and / or a rusty appearance to develop.
- 11 Preheat instruments in autoclave before allowing steam to enter, if possible, to prevent an excessive amount of condensation forming on the surface of the instruments.
- 12 Don't open the autoclave too quickly after the sterilisation cycle as excessive condensation will develop on the surface of the instruments (crack the clave to allow drying before opening fully).

If you follow the above rules and use instrument cleaners and lubricant milk such as our products, your instruments should remain rust, spot and stain free. I hope this will answer any questions you might have on this topic.





depuis 2011

**L'EXCELLENCE
AU SERVICE DES
CABINETS DENTAIRES**

**CONTACTEZ-NOUS OU COMMANDEZ SUR
NOTRE SITE INTERNET POUR BÉNÉFICIER
DE CES OFFRES EXCLUSIVES.**

PRODENTALPES

 06 01 21 16 35

 contact@prodentalpes.fr

 ZI DES DRAGIEZ, 30 RUE DE GRÉBELIN,
74800 LA ROCHE-SUR-FORON



10 000 PRODUITS TOUTES MARQUES

Totalement indépendant des laboratoires, nous sommes à votre écoute et nous vous conseillons de façon totalement objective.

Visitez le site prodentalpes.fr



Découvrez nos Promotions & Formations